



DuraLabel **KODIAK**

USER GUIDE



800-788-5572

GraphicProducts.com

Copyright Information

No part of this manual, including the products and software described in it, may be reproduced, transmitted, transcribed, stored in a retrieval system, or translated into any language in any form or by any means, except documentation kept by the purchaser for backup purposes, without the express written permission of Graphic Products, Inc.

Products and corporate names appearing in this manual may or may not be registered trademarks or copyrights of their respective companies, and are used only for identification or explanation and to the owners' benefit, without intent to infringe.

Specifications and information contained in this manual are furnished for informational use only, and are subject to change at any time without notice, and should not be construed as a commitment by Graphic Products. Graphic Products assumes no responsibility or liability for any errors or inaccuracies that may appear in this manual.



Home of DuraLabel 

Contents

1. Introduction	4
2. Warranties	5
2.1 5-Year DuraLabel Printer Warranty	5
2.2 5-Year DuraLabel Premium Vinyl Warranty	6
3. Safety Instructions	7
4. Getting to Know Your Kodiak	8
4.1 In the Box	8
4.2 Your Kodiak	9
4.3 Kodiak Home Screen	11
5. Loading Supplies	14
5.1 Loading Label Stock	14
5.2 Loading Printing Ribbons	15
6. Connecting Kodiak to a PC (Optional)	17
6.1 Initial Setup and Driver Installation	17
6.2 LabelForge PRO Software Installation	18
7. Creating Signs and Labels	19
7.1 Label Designer	19
7.2 Arc Flash	25
7.3 Chemical Labeling	28
7.4 NFPA/RTK	32
7.5 Pipe Marking	36
7.6 Additional Options in LabelForge PRO Software	41
8. Additional Functions	43
8.1 Supply Status Utility	43
8.2 Printing Preferences	43
8.3 Networking Settings	45
8.4 System Utilities	49
9. Maintenance and Troubleshooting	51
9.1 Cleaning Your Kodiak	51
9.2 Troubleshooting	53
10. Specifications	55
10.1 Capabilities	55
10.2 Printer Body	55
10.3 Print System	55
10.4 Interface	55
10.5 Communication and Data Storage	56
10.6 Power Requirements	56
10.7 Environment	56
10.8 Label Stock	56
10.9 Ribbon Supply	56
11. Certifications	57
11.1 Radio Compliance	57
11.2 Standard Conformity	57
11.3 Printer Disposal/Recycle	58
12. Third-Party Software	59

1. Introduction

With your DuraLabel Kodiak, you can create fully customized industrial signs and labels, on-site and on-demand.

Kodiak uses built-in label design software and two-color printing capabilities for powerful, effective, and efficient sign creation. You can also use the included LabelForge PRO label design software to create designs on your PC, printing them on Kodiak using a standard USB connection. Kodiak can even connect to a wireless network and dynamically populate your label designs with information from a database, using ODBC functionality.

This guide will provide information and instructions on your Kodiak. You can also watch instructional videos right on your system, and you can get help from Graphic Products' world-class support team by calling 800-788-5572 or visiting *GraphicProducts.com*.

2. Warranties

2.1 5-Year DuraLabel Printer Warranty

Graphic Products' DuraLabel printers are warranted to be free from defects in materials and workmanship for a period of five (5) years from the date of purchase. Within this period, Graphic Products, Inc. will, at its sole option, repair or replace any components which fail in normal use. Such repairs or

replacement will be made at no charge to the purchaser for parts or labor, provided that the purchaser shall be responsible for any transportation cost. This warranty does not cover loss, damages from accident, or equipment or parts which have been misused, altered, neglected, carelessly handled, used for purpose other than those for which the printer was manufactured, or damages resulting from unauthorized service.



2.1.1 REPAIRS

Repairs are warranted for 90 days. If the original warranty is still in effect, repaired units will remain under their original warranty or for 90 days from the date of service, whichever is longer.

2.1.2 WARRANTY DETAILS

The warranties and remedies contained herein are exclusive and in lieu of all other warranties whether express, implied, or statutory, including any liability arising under any warranty of merchantability or fitness for a particular purpose, statutory or otherwise. This warranty gives the purchaser specific legal rights, which may vary from state to state.

In no event shall Graphic Products be liable for any incidental, special, indirect, or consequential damages, whether resulting from the use, misuse, or inability to use the product for any reason including defect. Some states do not allow the exclusion of incidental or consequential damages, so the above limitation may not apply in all areas.

Graphic Products retains the exclusive right within all warranty periods to repair, replace, or offer a full refund of the purchase price at its sole discretion. Such remedy shall be the purchaser's sole and exclusive remedy for any breach of warranty.

General maintenance and cleaning of the DuraLabel printer is the purchaser's responsibility and is not covered by the warranty. Expendable items or parts such as label supply and ribbon are not covered by this warranty.

NOTE: Specific preparation may be required before shipping. Please contact your Graphic Products representative to ensure correct return procedure: please call 800-788-5572 for details. Graphic Products, Inc. shall not be responsible for any loss or damages incurred during shipping.

2. WARRANTIES

2.2 5-Year DuraLabel Premium Vinyl Warranty

DuraLabel supplies are tested for durability under various conditions, including UV exposure, moisture, heating and cooling cycles, abrasion, and chemical exposures. Graphic Products warranties labels made from its Premium vinyl supplies for a period of five (5) years.

Within five years of purchase and after proper application, Graphic Products will replace labels made with DuraLabel Premium Vinyl which become unreadable or fail to maintain adhesion with the labeled surface. In such instance, Graphic Products, Inc. will provide a one-time replacement roll of the same supply.

3. Safety Instructions

Please review the following safety instructions before using the printer:

- Kodiak is intended for indoor use only. Keep the printer away from humidity and prolonged exposure to direct sunlight.
- Disconnect the printer from its power source when not in use.
- Do not pour liquids onto the printer or printer parts. For ordinary cleaning, follow the instructions included in this guide.
- Only qualified service personnel should attempt to repair the printer.

NOTE: Changes or modifications not expressly approved by the party responsible for compliance could void the user's authority to operate the equipment.

In addition, to prevent damage to Kodiak and to avoid nullifying the Kodiak warranty, please follow these rules:

- Only use official Kodiak supplies from Graphic Products in your Kodiak printer.
- Read all instructions in this manual completely.

If something seems to be wrong with Kodiak, refer to the Maintenance and Troubleshooting section of this guide. If the problem is not resolved by following the recommended steps, please contact Graphic Products by calling 800-788-5572 or visiting GraphicProducts.com.

4. Getting to Know Your Kodiak

Kodiak is a thermal transfer printer, meaning that it uses heat to transfer a solid resin or “ink” from a printing ribbon onto a label stock. With two separate print heads and two separate ribbons, Kodiak can print in two colors on the same label.

Kodiak is larger and heavier than some printers, weighing about 42 pounds (about 20 kilograms). We recommend having two people work together to unpack or reposition the printer.

4.1 In the Box

In Kodiak’s box, you will find the following materials:

- Kodiak Printer
- Blank Ribbon Cartridge (1)
- Ribbon Cartridges (2)
- Kodiak User Guide (this document)
- Kodiak Quick Start Guide
- Power Cord
- USB Cable
- Software CD
- Wireless Keyboard (stowed inside the printer’s lid)
- Wi-Fi USB Adapter (already plugged in, behind the removable back panel)



4.2 Your Kodiak

4.2.1 FRONT VIEW



1. Print Button - Prints one copy of the current label design (if any)
2. X (Cancel) Button - Cancels the current print job (if any)
3. ? (Help) Button - Opens the help interface for the current program, or shows Kodiak version information (if on the Home Screen)
4. USB-A ports (2)
5. Adjustable Touchscreen
6. Cutter

4.2.2 BACK VIEW

1. Power Socket
2. Power Switch
3. USB-B Port
4. Ethernet Port
5. *Behind Removable Panel:*
USB-A Ports for wireless
keyboard receiver and Wi-Fi USB
Adapter

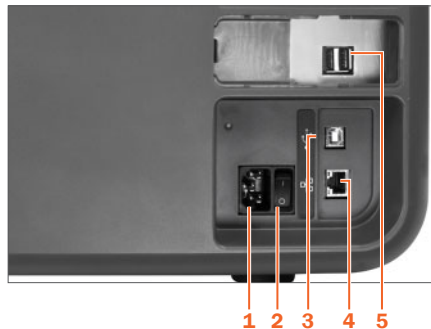

4. GETTING TO KNOW YOUR KODIAK

4.2.3 INSIDE

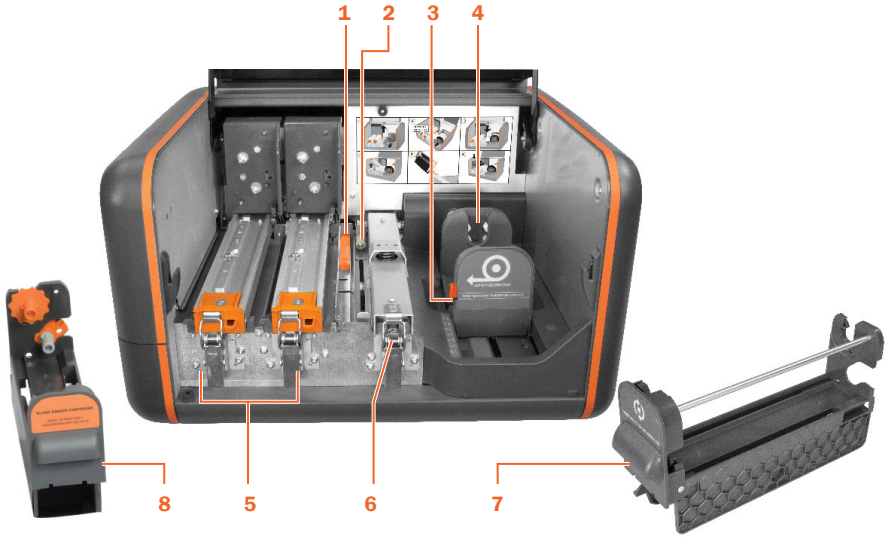

- | | |
|---------------------------------|--------------------------------|
| 1. Supply Sensor | 5. Print Heads and Latches (2) |
| 2. Adjustable Supply Guides | 6. Feed Roller Bar and Latch |
| 3. Supply Holder Adjustment Tab | 7. Ribbon Cartridges (2) |
| 4. Adjustable Supply Holders | 8. Blank Ribbon Cartridge |

4.3 Kodiak Home Screen

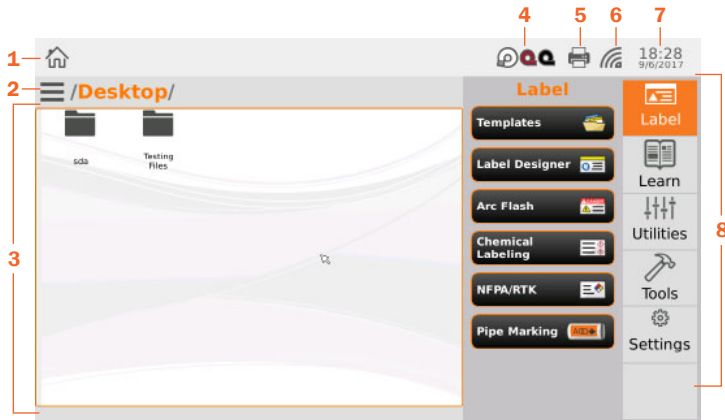

- | | |
|------------------------------|--------------------------------|
| 1. Home Button | 5. Printing Preferences/Status |
| 2. Hamburger Menu | 6. Network Settings |
| 3. Desktop Area | 7. Date/Time |
| 4. Supply/Ribbon Information | 8. Main Menu |

The Kodiak home screen will appear when you start the system, and you can return to it by clicking the Home button. The main menu on the right of the screen lists the general options that are available: Label, Learn, Utilities, Tools, and Settings.

4.3.1 LABEL

This menu includes options for creating or printing labels and signs. The options here are:

- **Templates:** Browse existing templates for signs or labels on your Kodiak.
- **Label Designer:** Design new signs or labels from scratch, or modify existing designs.
- **Arc Flash:** Enter data for specialized electrical safety signage, and print labels that comply with the NFPA 70E and CSA Z462 standards.
- **Chemical Labeling:** Create GHS-style chemical labels for safety and compliance, using an editable database of chemical details. Labels can follow HazCom 2012 (United States) or international GHS (UN) formats.
- **NFPA/RTK:** Create supplemental chemical labels with the NFPA 704 hazard ratings, using an editable database of chemical details.
- **Pipe Marking:** Quickly design pipe labels to match ANSI/ASME A13.1 or the IIAR Bulletin No. 114 standards.

4. GETTING TO KNOW YOUR KODIAK

4.3.2 LEARN

This menu includes ways for you to learn about major topics or find the answers to your questions. The options here are:

- **Label Examples:** Examples of completed labels and signs in a variety of styles.
- **Manuals:** Documentation for your Kodiak and its associated software.
- **Videos:** Helpful how-to videos, including how to load supplies into your Kodiak.

4.3.3 UTILITIES

This menu is for maintaining and updating your Kodiak system. The options here are:

- **Database Manager:** Create, copy, import, or export databases for use with the labeling modules.
- **Font Installer:** Add a standard .ttf font file to your Kodiak's list of available fonts.
- **Touch Calibration:** If Kodiak's touchscreen seems to respond strangely, you can recalibrate it here.
- **Updater:** View a list of the different applications on your Kodiak and automatically update them, using a Wi-Fi connection or a USB storage device with downloaded software.
- **Users and Passwords:** Manage usernames and passwords to control access to your Kodiak.

4.3.4 TOOLS

This menu offers direct access to specific applications on your Kodiak. The options here are:

- **Calculator:** Perform basic math functions.
- **Character Map:** Browse and copy special characters for use in your labels and signs.
- **Graphic Viewer:** View image files on your Kodiak.
- **PDF Viewer:** Read documents in the standard PDF style.
- **Spreadsheet:** View and make basic edits to basic spreadsheet files.
- **Text Editor:** Read or write plain text documents.
- **Video Player:** Play video files in .ogv format.

4.3.5 SETTINGS

This menu is for your Kodiak's system settings. The options here are:

- **Preferences:** These are the detailed controls for how your Kodiak will handle print jobs.
- **Supply Status:** See which supplies are currently loaded, and how much of each is remaining. You can also access this utility by tapping on the small supply icons in the main toolbar at the top of the screen.
- **Date and Time:** Adjust Kodiak's internal clock or calendar. You can also access these settings by tapping on the time or date displayed in the main toolbar at the top of the screen.
- **Networking:** View or change Kodiak's network settings to connect to a wireless or Ethernet network. You can also access these settings by clicking the network icon in the main toolbar at the top of the screen.

5. Loading Supplies

To load your Kodiak with supplies, raise the hinged lid. The lid will hold at the fully raised position.

5.1 Loading Label Stock

The label stock is the base material for your labels or signs, serving as the “paper” for the printing process. Label stock is available in a variety of materials, types, sizes, and colors. Each roll of Kodiak label stock is sold as a roll with geared plastic end caps. Do not remove these end caps, or the supply will not fit properly in your Kodiak.

When loading label stock, make sure that it is not folded, and lies flat and smooth. This will prevent supply jams during printing.

To load label stock, follow these steps:

1. Squeeze the orange tab on the front adjustable supply holder, and slide the holder to the position marked for your supply width. (The adjustable supply holders are paired to move together and keep your supply centered properly.)
2. Hold the roll of label stock so that the end cap with a Kodiak label faces you. Then, rest the gears on the supply’s end caps into the slots on the supply holders.
3. Unlatch the feed roller bar and allow it to raise. (This bar is spring-loaded.) Pull the end of your label stock away from the roll, and under this bar.
4. Check that the leading edge of your label stock is clean, straight, and smooth; if not, use scissors to cut it into a straight line.
5. Slide the adjustable supply guides to keep your label stock between them and under the white rollers, so the label stock remains centered. Continue to feed the label stock under the metal guide, immediately to the left of those supply guides.
6. Lower the feed roller bar and latch it down.

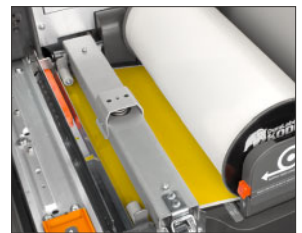
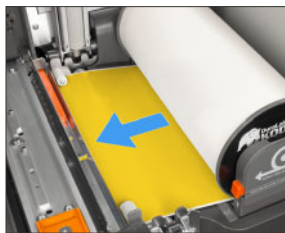
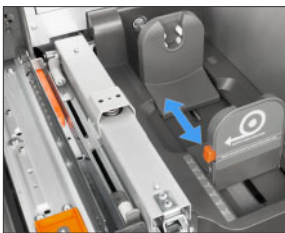

When you finish loading supplies and close the printer lid, Kodiak will automatically detect which type of label stock has been loaded.

5.2 Loading Printing Ribbons

The printing ribbons provide the “ink” for the printing process. Each new ribbon is sold as a roll, which can be loaded into a ribbon cartridge; the cartridges are then installed into Kodiak by sliding them into place over the print heads. As labels are printed, the used ribbon will be collected on take-up rolls for later disposal.

There are two print heads, marked with the numbers “1” and “2.” Each print head needs a ribbon cartridge loaded with ribbon and installed properly in order for Kodiak to print. To use only one printing ribbon at a time (for labels with only one printed color), you will need to install one cartridge with ribbon loaded normally, and the blank ribbon cartridge, which is marked with an orange faceplate.

5.2.1 LOADING RIBBON INTO A RIBBON CARTRIDGE

Start with an empty ribbon cartridge. If your cartridges are already loaded into your Kodiak, you can remove them by unlatching each print head and raising it by lifting its orange tab. When the print head is fully raised, it will lock into place, and you can simply slide the cartridge out by pulling its handle.

To load a new ribbon into a ribbon cartridge, follow these steps:

1. Insert an empty ribbon take-up roll into the slots at the top of the cartridge. Press firmly at each end to click the take-up roll into place.
2. Insert a fresh ribbon roll into the side of cartridge. Align the arrow on the ribbon end cap with the arrow on the side of the cartridge; then, press firmly at each end to click the ribbon into place.
3. Check the edge of the ribbon cartridge just below the fresh roll of ribbon, above the honeycomb pattern. If there is visible residue from previous ribbons, remove it with a cleaning swab or a soft cloth moistened with isopropyl alcohol, and let the cartridge dry before continuing.
4. Find the end of the roll of ribbon. Pull it out, and unwind it around the bottom of the cartridge, and up to the take-up roll. Adhere the ribbon to the take-up roll, using a piece of tape, if needed.
5. Take up any slack in the ribbon by turning the take-up roll. Your cartridge is now ready to install into Kodiak.



5. LOADING SUPPLIES

5.2.2 INSTALLING A RIBBON CARTRIDGE INTO KODIAK

If a print head is in its lowered position, you will need to raise it in order to install a ribbon cartridge there; unlatch the print head and raise it by lifting its orange tab.

To install a loaded ribbon cartridge into your printer, follow these steps:

1. Holding a loaded ribbon cartridge by its handle, slide the cartridge onto the print head. The loose section of ribbon should fit just below the print head, and the cartridge should slide smoothly on its rails.
2. Gently push the cartridge all the way back, so the number on the print head is visible. You may hear the cartridge click into position.
3. Lower the print head by its orange tab, and latch it down.



If you are using a black ribbon along with any other ribbon color, we recommend loading the black ribbon in position 2 (which prints last) for the best possible print quality, and to allow overprinting.

If you are using a white ribbon along with any other ribbon color, we recommend loading the white ribbon in position 1 (which prints first) for the best possible print quality, and to allow white base printing.

If you are using one printing ribbon and one blank ribbon cartridge (marked with an orange faceplate), the blank ribbon cartridge must be loaded in position 1.

When you finish loading supplies and close the printer lid, Kodiak will automatically detect which type of ribbon has been loaded at each print head.

6. Connecting Kodiak to a PC (Optional)

Kodiak's built-in touchscreen allows you to create signs and labels even without a computer, but you can also connect Kodiak to a computer for additional versatility.

6.1 Initial Setup and Driver Installation

When connecting Kodiak to a computer for the first time, follow these steps.

NOTE: You will need administrator privileges to install a driver.

1. Connect Kodiak's power cable to an electrical outlet, and connect the USB cable from the USB-B port on the back of your Kodiak (near the power switch) to a USB-A port on your computer. Turn on your Kodiak using the power switch on the back of the printer.
2. Insert the DuraLabel Kodiak Installation CD into your computer's CD drive. When the DuraLabel Kodiak startup screen appears, choose Install Driver. (To continue without a CD drive, or for updated software in the future, you can also download the software at GraphicProducts.com/support.)
3. Accept the license agreement and click Next.
4. Choose an installation directory; by default, this will be "C:\Program Files (x86)\DuraLabel Kodiak." Then, click Next.
5. Review the installation details and click Finish to install the driver. You will see a progress bar as the software is installed.

You will be prompted to restart your computer to complete installation. Save any work before restarting.

6.2 LabelForge PRO Software Installation

After the driver software is installed, Kodiak will appear as an available printer on your computer whenever it is connected and powered on. For best results, use the LabelForge PRO software on your PC to create designs to be printed on Kodiak. Other software may give unexpected printing results.

NOTE: You will need administrator privileges to install the design software.

1. Insert the DuraLabel Kodiak Installation CD into your computer's CD drive. When the DuraLabel Kodiak startup screen appears, choose Install LabelForge PRO. (To continue without a CD drive, or for updated software in the future, you can also download the software at GraphicProducts.com/support.)
2. Accept the license agreement and click Next.
3. Choose an installation directory; by default, this will be "C:\Program Files (x86)\Label Forge Pro." Then, click Next.
4. Review the installation details and click Finish to install LabelForge PRO. You will see a progress bar as the software is installed.

For details on using LabelForge PRO to design labels and signs, see the following section.

7. Creating Signs and Labels

Kodiak includes several ways to create new labels or signs. Each of the labeling modules is available through the Label menu on the main screen. The modules are also included as part of the LabelForge PRO software for your PC.

7.1 Label Designer

The Label Designer module is meant for creating or editing completely custom designs, using text, images, or barcodes. These items can be placed and modified with the menus, and can be moved around your label by dragging them on the design area.

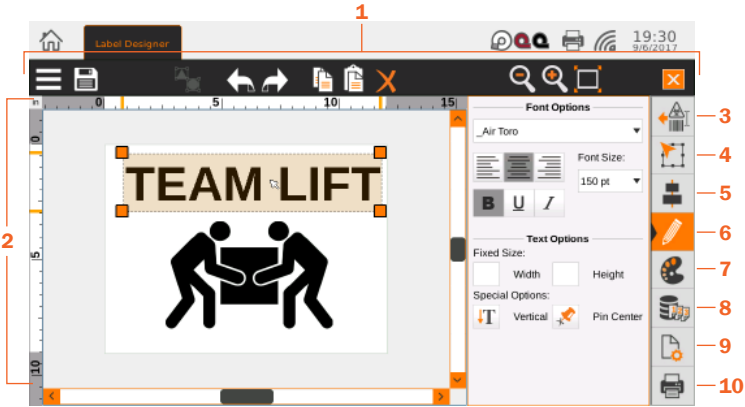

- 1. Toolbar
- 2. Design Area
- 3. Insert menu
- 4. Dimensions menu
- 5. Order menu
- 6. Details menu
- 7. Color menu
- 8. Data Source menu
- 9. Label Settings menu
- 10. Print Settings menu

7. CREATING SIGNS AND LABELS

7.1.1 TOOLBAR

The toolbar across the top of the screen shows some common controls and options for the Label Designer.



- 1. Hamburger Menu:** Access common file options, such as creating a new design, saving and loading designs, and choosing program settings.
- 2. Quick Save:** Save the current label design with its current file name. If you haven't saved the file yet, you will be prompted to choose a file name and location.
- 3. Group/Ungroup:** Set a group of selected objects to act as a single large object, or reverse this choice. Grouped objects will be moved and resized together.
- 4. Undo/Redo:** Cancel a recent action, or repeat a canceled action.
- 5. Copy/Paste/Delete:** Duplicate or remove the selected object.
- 6. Zoom Out/In/Fit:** Adjust your view of the design to allow fine tuning.
- 7. Close:** Close the Label Designer.

7.1.2 CREATING A LABEL DESIGN

When you open Label Designer or choose the New Label option in the Hamburger Menu, the New Label window will open.

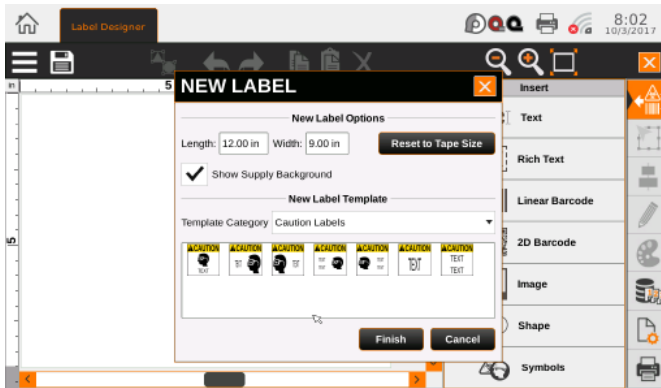

The New Label Options include the length and width of your design. You can also click Reset to Tape Size to set your label dimensions to the default size for your loaded label stock. If your loaded label stock uses pre-printed elements, check the Show Supply Background checkbox to show those preprinted elements on the screen.

The New Label Template section of the window lets you choose a premade template to apply to your new design, such as an ANSI-style warning template or a basic barcode template. By default, you will start with a blank label (with no elements in place), but you can also choose a Template Category from the drop-down menu and choose a template from the previews that appear. These templates will be automatically adjusted to fit your label's dimensions.

Once you have made your selections, click Finish to start designing your label.

7. CREATING SIGNS AND LABELS

7.1.3 INSERT MENU AND DESIGN OBJECTS



Each object on your label, such as a text box or an image, is added to your label through the Insert Menu.

Click on the desired item type to add it to the center of your label; when an object has been added to the design, the new object will automatically be selected for editing.

- **Text:** Add simple text items to your label, useful for headers or static information. Basic text can be set to a fixed size or locked in place.
- **Rich Text:** Add rich text items, useful for descriptive or dynamic content. Rich text can wrap within a box, and different parts of the same item can use different font styles.
- **Linear Barcode:** Add a line-style barcode in a variety of formats. Supported formats are Codabar, Code 128, Code 128B, Code 2 of 5 (Interleaved 2 of 5), Code 39, EAN13 (ISBN), EAN8 (8-2, 8-5), UPC-A (A2, A5), and UPC-E (A2, A5).
- **2D Barcode:** Add a grid-style barcode in a variety of formats. Supported formats are Data Matrix, PDF417, and QR Code.
- **Image:** Import a custom image, such as a company logo. Selecting this option will prompt you for the file that you want to use; supported file types are .bmp, .gif, .jpg/.jpeg, .png, and .svg.
- **Shape:** Add geometric shapes such as lines, rectangles, and circles to your design. You can change the style of a selected Shape object by clicking on a different shape in the menu.
- **Symbols:** Add standardized symbols from a massive library, sorted by categories such as “Arrows,” “Injury,” and “Prohibited.” Choose a category on the left side of the Symbols window, select the desired symbol on the right side, and click the Insert button to add that symbol to your design.

7.1.4 DIMENSIONS MENU



When an object is selected, use this menu to precisely control the object's size, location, or rotation. You can also quickly adjust an object's size by dragging the control boxes at its corners, or move the object by dragging it across the design area.

7.1.5 ORDER MENU



When an object is selected, use this menu to adjust the object's arrangement relative to other objects or the label as a whole. You can center objects on the label, or align multiple selected objects to each other. You can also control whether an object covers up another, or is covered instead.

7.1.6 DETAILS MENU

When an object is selected, use this menu to adjust the unique options available for that type of object. For example, for text objects, you can change the font and size, while for barcode objects, you can choose the barcode format.

7.1.7 COLOR MENU

When an object is selected, use this menu to choose the colors for that object. You can select a wide variety of colors, even if the appropriate supplies are not currently loaded, but only colors that match your loaded supplies can be printed accurately.

7.1.8 DATA SOURCE MENU AND AUTOMATIC LABEL CONTENT

Connect your label design to a spreadsheet or database, and automatically generate a series of matching labels, or add automatically-generated content to your existing label design.

To use this function, start by selecting the type of Data Source that you want to use, from the drop-down menu:

- **ArcFlash:** Pull information from an arc flash database, like the one used by Kodiak's Arc Flash labeling module.
- **CSV:** Use a spreadsheet that has been saved in the widely-used Comma-Separated Value (CSV) format.
- **DSN:** Use a Data Source Name to get information from a database, following ODBC protocols. Network connections are possible; check with your IT team for help.
- **Function:** When using other Data Sources, the Function option lets you apply additional formatting to the information from those sources. It also provides a way to use more than one Data Source in a single design object, such as a product name immediately followed by its part number and description.
- **GHS:** Pull information from a GHS-style chemical database, like the one used by Kodiak's Chemical Labeling module.
- **ImageFolder:** Select a folder of images to print, with each image appearing on its own label. The files will need to be available on your Kodiak.
- **NFPA:** Pull information from an NFPA-style chemical database, like the one used by Kodiak's NFPA/RTK labeling module.
- **Sequence:** Set up a sequence of numbers, automatically counting from a given start value to a given end value. You can also add a prefix, suffix, or zero padding. No separate file is needed.

7. CREATING SIGNS AND LABELS

- **SQLite:** Use the SQLite database management system to get information from a database. Network connections are possible; check with your IT team for help.
- **TextList:** Set up a sequence of text phrases, with each phrase appearing on its own label.
- **Time:** Add the current date or time (as set on your Kodiak or PC) to each label as it is printed.
- **XLSX:** Use a spreadsheet that has been saved in the Microsoft Excel workbook format (Excel 2007 or newer).

(For the ArcFlash, CSV, GHS, ImageFolder, NFPA, or XLSX Data Source types, the necessary file or files will need to be available on your Kodiak, or on your computer if you are using the PC version of LabelForge PRO.)

After selecting the type of Data Source you want to use, click Add. Make the appropriate selections in this window to set up your Data Source.

Once a Data Source has been set up, select a Text, Rich Text, Linear Barcode, or 2D Barcode object on your design. (If you are using an ImageFolder, select an Image or Symbol object instead.) Then, select the desired field from the Data Source Field dropdown menu. The object will be automatically updated to reflect the contents of that field for the current record in the Data Source.

The Navigation section at the bottom of the Data Source menu shows the current record and the total number of records in the current Data Source. You can also cycle through the records or jump to a specific record.

7.1.9 LABEL SETTINGS MENU

Choose basic label design options, such as the size of the label you are creating (or a dynamic size, which extends or shrinks to match your content) and the supplies you plan to use when printing your label.

7.1.10 PRINT SETTINGS MENU

Adjust printing options, such as the common printing preferences. You can also choose which labels to print from an automatically-generated set of labels, if you are using a Data Source.

When you are ready to print your label, click the Print button in the Print Settings menu. If you are using the Kodiak's built-in screen for your label designs, you can also press the physical Print button on the front of your Kodiak to print one copy of the current label, using the current print settings.

7.2 Arc Flash

The Arc Flash module uses a searchable, editable database to keep track of your equipment details, and simplify the task of creating arc flash warning labels that match the NFPA 70E and CSA Z462 standards.

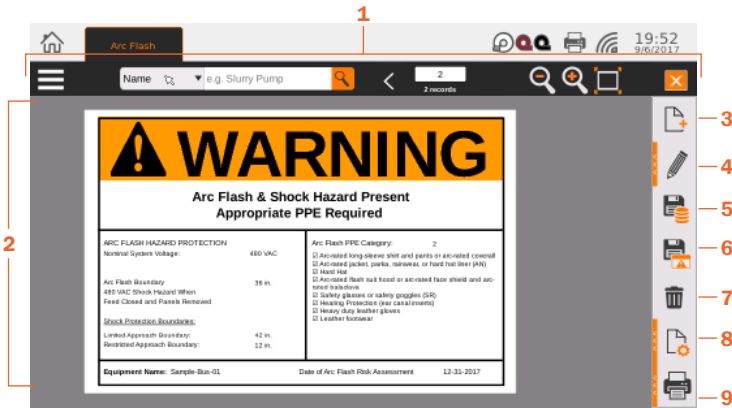

- | | | |
|----------------|-------------------------|-------------------------|
| 1. Toolbar | 4. Edit Record | 7. Delete Record button |
| 2. Design Area | 5. Save Database button | 8. Label Settings menu |
| 3. New Record | 6. Save Label button | 9. Print Settings menu |

7.2.1 TOOLBAR

The toolbar across the top of the screen shows some common controls and options for the Arc Flash labeling module.



- 1. Hamburger Menu:** Access common file options, such as creating a new record, saving records, and exporting label designs.
- 2. Search Records:** Search the arc flash database by equipment name, date, or project name.
- 3. Record Number:** Identify the current record, out of the current database or search results.
- 4. Zoom Out/In/Fit:** Adjust your view of the design to allow fine tuning.
- 5. Close:** Close the Arc Flash labeling module.

7.2.2 NAVIGATING RECORDS IN THE DATABASE

The fastest way to find a specific record in the Arc Flash database is with the toolbar's search function.

1. Choose whether to search by Name (of the equipment), Date (of the arc flash risk assessment), or Project. The default search is by equipment name; to change this selection, click the current search type (such as "Name") in the toolbar, and make a new selection.
2. Type your search terms in the search box, and click the magnifying glass button or press Enter on your keyboard.
3. The first match (in alphabetical order, by equipment name) will be shown in the design area. Use the right or left arrows in the toolbar to browse through the search results.

The number in the white box on the toolbar shows which search result you are currently seeing; the number below the box shows the total number of search results. If you do not enter any search terms, you can browse through the entire current database.

7.2.3 CREATING AND EDITING ARC FLASH RECORDS

To create a new entry in your current Arc Flash database, click the New Record button in the menu on the right. This creates a new, blank record. The Edit menu will slide out to let you add the details for this new material. This is where you will enter the details for the current label:

1. **Label Options:** Choose the Danger, Warning, or Caution header, and choose a project (or type a new project name) to keep related labels together.
2. **Label Information:** Enter the basic information for this label (equipment name, nominal voltage, arc flash boundary, and assessment date).
3. **PPE Information:** Choose whether the label will show an Arc Flash PPE Category or a calculated Incident Energy and Working Distance, and enter the appropriate information.
4. Also in the PPE section is the button for "List of PPE." This will open a window where you can select the complete list of required PPE items by checking the box for each required item. By default, the list of PPE is alphabetical, but you can also sort the list by PPE categories: click the number for the category you want listed first. If desired, you can add, remove, or edit PPE items in this list as well.
5. **Shock Hazards:** Enter the voltage and conditions of a shock hazard, as well as the Limited Approach Boundary and Restricted Approach Boundary.

When the details have been entered, click the Save Database button to add your new entry to the Arc Flash module's current database. The Save Label button will export your current label design to its own file, so you can adjust the design in the Label Designer module. If you want to remove the current record from the database, click the Delete Record button.

7.2.4 TEMPLATES, SIZES, AND SETTINGS

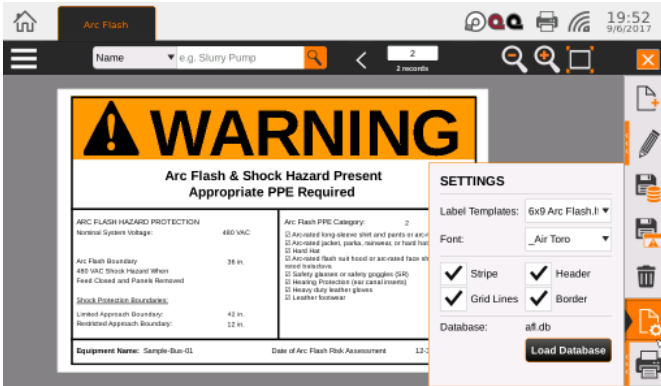

To print Arc Flash labels in different sizes, or to use custom templates, open the Label Settings menu and select the appropriate template with the drop-down Label Templates menu. The default templates are named so that the size of the label is shown first (with dimensions in inches).

In the same menu, you can also choose a font for the text of your label, and you can toggle optional label elements (such as grid lines or a border). You can also choose whether to print the colored stripe at the top of the label, or the header text and alert symbol; disable these options if you are using pre-printed label stock with those elements already in place.

This menu also lets you select which arc flash database you are using, if more than one database is available.

7.2.5 PRINTING A LABEL

When you are ready to print, click the Print Settings button. Here, choose which labels you want to print, and how many copies of each. You can also check a Print Preview here.

Click the Print button to start the new print job. If you are using the Kodiak's built-in screen for your label designs, you can also press the physical Print button on the front of your Kodiak to print one copy of the current label, using the current print settings.

7.3 Chemical Labeling

The Chemical Labeling module uses a searchable, editable database of chemical information to make GHS-style container labels. The module allows you to use the HazCom 2012 format (US/OSHA), standardized GHS (for international use), or custom templates.



- | | | |
|----------------|------------------|-------------------|
| 1. Toolbar | 4. Edit Record | 7. Delete Record |
| 2. Design Area | 5. Save Database | 8. Label Settings |
| 3. New Record | 6. Save Label | 9. Print Settings |

7.3.1 TOOLBAR

The toolbar across the top of the screen shows some common controls and options for the Chemical Labeling module.



- 1. Hamburger Menu:** Access common file options, such as creating a new record, saving records, and exporting label designs.
- 2. Country/Authority Menu:** Choose the format for your chemical labels: OSHA's HazCom 2012 format, the UN's international GHS format, or a custom style.
- 3. Search Records:** Search Kodiak's GHS-style chemical database by product name or identifying number.
- 4. Record Number:** Identify the current record, out of the current database or search results.
- 5. Zoom Out/In/Fit:** Adjust your view of the design to allow fine tuning.
- 6. Close:** Close the Chemical Labeling module.

7.3.2 NAVIGATING RECORDS IN THE DATABASE

The fastest way to find a specific record in the Chemical Labeling database is with the toolbar's search function.

1. Choose whether to search by Product Name or one of the material's identifying numbers (UN number, CAS Number, or EC Number). The default search is by chemical name; to change this selection, click the current search type (such as "Name") in the toolbar, and make a new selection.
2. Type your search terms in the search box, and click the magnifying glass button or press Enter on your keyboard.
3. The first match (in alphabetical order, by equipment name) will be shown in the design area. Use the right or left arrows in the toolbar to browse through the search results.

The number in the white box on the toolbar shows which search result you are currently seeing; the number below the box shows the total number of search results. If you do not enter any search terms, you can browse through the entire current database.

7.3.3 CREATING AND EDITING CHEMICAL RECORDS

To create a new entry in your current chemical database, click the New Record button in the menu on the right. This creates a new, blank record. The Edit menu will slide out to let you add the details for this new material. (To edit an existing chemical entry, simply find that entry in the database and click the Edit Record button in the menu.)

- 1. Edit Label:** Set the basic details for this entry, such as the product name, identifying numbers, signal word, and any supplemental information.
- 2. Hazard Symbols:** Click on a symbol to make it appear on this label. Current symbols will be highlighted in orange; click on the symbol again to remove it.
- 3. Click the Hazard Statements button** to open a new window and select the hazard statements for your material.
 - a.** In this window, select an appropriate statement from the full list on the left (sorted by reference code). To find a specific statement, type in the search box in the lower left. When the desired statement has been selected, click Add Statement to add it to the current list, on the right.
 - b.** For hazard statements with additional details, select the statement and type the appropriate information in the parameter fields in the lower right. For compliance with standards, hazard statements cannot be freely edited.
 - c.** If you need to remove a statement from the current list, select it and click Remove Statement.
 - d.** When you've added the appropriate Hazard Statements, click OK to continue.
- 4. Click the Precautionary Statements button** to open a new window for these statements. As with Hazard Statements, select a statement from the left and click Add Statement.
 - a.** As with Hazard Statements, select an appropriate statement from the full list on the left (sorted by reference code). To find a specific statement, type in the search box in the lower left. When the desired statement has been selected, click Add Statement to add it to the current list, on the right.
 - b.** Precautionary statements can be edited by selecting a statement and typing. You can also add a blank statement with the Create Statement button to add your own customized text. Individual statements are separated by periods.
 - c.** If you need to remove a statement from the current list, select it and click Remove Statement.
 - d.** When you've added the appropriate Precautionary Statements, click OK to continue.

5. **Supplier:** If you have already entered information for the supplier or other responsible party, you can select that organization from the drop-down list. To add a new supplier or edit supplier information, click the Pencil button; this will open a new window for supplier details.

When the details have been entered, click the Save Database button to add your new entry to the Chemical Labeling module's current database. The Save Label button will export your current label design to its own file, so you can adjust the design in the Label Designer module. If you want to remove the current record from the database, click the Delete Record button.

7.3.4 TEMPLATES, SIZES, AND SETTINGS

To print chemical labels in different sizes, open the Label Settings menu and select the appropriate template with the drop-down Label Size menu. In the same menu, you can also choose a font for the text of your label.

This menu also lets you select which chemical database you are using, if more than one database is available.

7.3.5 PRINTING A LABEL

When you are ready to print, click the Print Settings button. Here, choose which labels you want to print, and how many copies of each. You can also check a Print Preview [here](#).

Click the Print button to start the new print job. If you are using the Kodiak's built-in screen for your label designs, you can also press the physical Print button on the front of your Kodiak to print one copy of the current label, using the current print settings.

7.4 NFPA/RTK

The NFPA/RTK module uses a searchable, editable database of chemical information to make supplemental chemical labels based on the NFPA 704 hazard rating system. This system assigns a numeric rating for a material's hazards in each of three categories (health, flammability, and instability).

The NFPA 704 labeling system and its variations were originally intended to protect first responders in an emergency. These labels may not satisfy the regulatory requirements that apply in your case; check with your local authorities to ensure compliance.

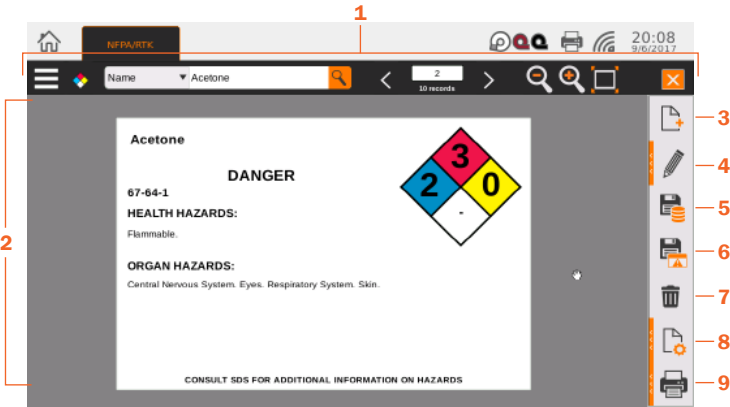

- | | | |
|----------------|------------------|-------------------|
| 1. Toolbar | 4. Edit Record | 7. Delete Record |
| 2. Design Area | 5. Save Database | 8. Label Settings |
| 3. New Record | 6. Save Label | 9. Print Settings |

7.4.1 TOOLBAR

The toolbar across the top of the screen shows some common controls and options for the NFPA/RTK module.



- 1. Hamburger Menu:** Access common file options, such as creating a new record, saving records, and exporting label designs.
- 2. Authority Menu:** Choose the format for your chemical labels, using the familiar NFPA Diamond layout or an alternative RTK Color Bar format.
- 3. Search Records:** Search Kodiak's NFPA-style chemical database by product name or CAS number.
- 4. Record Number:** Identify the current record, out of the current database or search results.
- 5. Zoom Out/In/Fit:** Adjust your view of the design to allow fine tuning.
- 6. Close:** Close the NFPA/RTK module.

7.4.2 NAVIGATING RECORDS

The fastest way to find a specific record in the NFPA/RTK database is with the toolbar's search function.

1. Choose whether to search by the material's Name or CAS Number. The default search is by chemical name; to change this selection, click the current search type (such as "Name") in the toolbar, and make a new selection.
2. Type your search terms in the search box, and click the magnifying glass button or press Enter on your keyboard.
3. The first match (in alphabetical order, by equipment name) will be shown in the design area. Use the right or left arrows in the toolbar to browse through the search results.

The number in the white box on the toolbar shows which search result you are currently seeing; the number below the box shows the total number of search results. If you do not enter any search terms, you can browse through the entire current database.

7.4.3 CREATING AND EDITING RECORDS

To create a new entry in your current NFPA-style chemical database, click the New Record button in the menu on the right. This creates a new, blank record. The Edit menu will slide out to let you add the details for this new material. (To edit an existing chemical entry, simply find that entry in the database and click the Edit button in the menu.)

- 1. NFPA Information:** Set the basic details for this entry, such as the product name, CAS number, and signal word.
- 2. Edit Rating:** Click the plus or minus buttons to adjust the ratings for the chemical, from 0 to 4.
- 3. Specific Ratings:** If your material poses a special hazard, such as being an oxidizer (OX) or simple asphyxiant (SA), click the arrow to expand this section. Check the box for any hazard that applies.
- 4. Health Hazards:** If your material poses a specific health hazard, such as being an irritant or carcinogen, click the arrow to expand this section. Check the box for any hazard that applies.
- 5. Organ Hazards:** If your material poses a direct hazard to specific organs, such as kidneys or respiratory system, click the arrow to expand this section. Check the box for any hazard that applies.
- 6. PPE Symbols:** If specific personal protective equipment (PPE) is required to safely handle this material, such as gloves or a respirator, click the arrow to expand this section. Check the box for any PPE symbol that you want to include. You can also add symbols to this list with the “Import” function.
- 7. Comments:** If there are additional comments you would like to include on the label, click the arrow to expand this section and type your comments in the field provided.

When the details have been entered, click the Save Database button to add your new entry to the Chemical Labeling module’s current database. The Save Label button will export your current label design to its own file, so you can adjust the design in the Label Designer module. If you want to remove the current record from the database, click the Delete Record button.

7.4.4 TEMPLATES, SIZES, AND SETTINGS

To print NFPA-style chemical labels in different sizes, open the Label Settings menu and select the appropriate template with the drop-down Label Templates menu. The default templates are named so that the size of the label is shown first (with dimensions in inches).

In the same menu, you can also choose a font for the text of your label, and toggle optional elements such as PPE symbols and comments. Not all templates allow for PPE symbols and/or comment text.

This menu also lets you select which NFPA-style chemical database you are using, if more than one database is available.

7.4.5 PRINTING A LABEL

When you are ready to print, click the Print Settings button. Here, choose which labels you want to print, and how many copies of each. You can also check a Print Preview [here](#).

Click the Print button to start the new print job. If you are using the Kodiak's built-in screen for your label designs, you can also press the physical Print button on the front of your Kodiak to print one copy of the current label, using the current print settings.

7.5 Pipe Marking

The Pipe Marking module uses the recommendations of the ANSI/ASME A13.1 standard to create simple and effective pipe labels. It also includes a specialized module for labeling the parts of ammonia-based refrigeration systems, following the IIAR Bulletin No. 114 approach. Finally, it includes a simple option for creating arrow wraps, which can be applied around the circumference of a pipe to show the direction of flow.

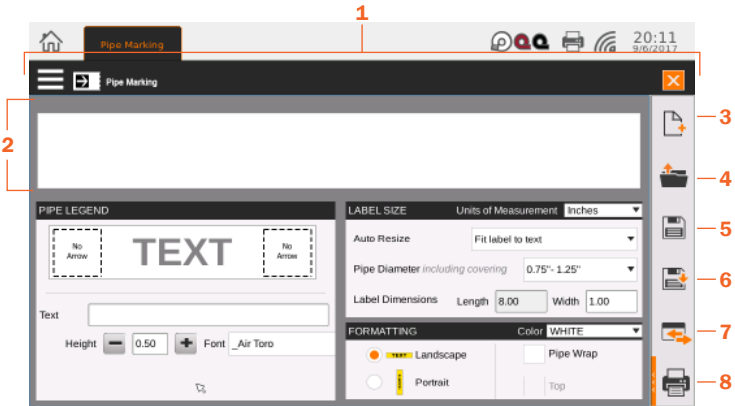

- 1. Toolbar
- 2. Label Preview
- 3. New Label button
- 4. Open Label
- 5. Save
- 6. Save As
- 7. Export Label
- 8. Print Settings

7.5.1 TOOLBAR

The toolbar across the top of the screen shows some of the options for the Pipe Marking module.



- 1. **Hamburger Menu:** Access common file options, such as creating a new label, saving labels, and exporting label designs. The most common choices here are also available in the menu on the right side of the screen.
- 2. **Module Menu:** Choose the type of pipe marker you are creating: basic ANSI/ASME labels, ammonia refrigeration pipe labels, or arrow wraps.
- 3. **Close:** Close the Pipe Marking module.

7.5.2 CREATING A BASIC PIPE MARKER

To create a new pipe label in the default ANSI/ASME A13.1 style, follow these steps:

First, decide on the printed content of your pipe marker, using the Pipe Legend box on the left side of the screen:

1. Click in the Text field and type the text that your label should include.
2. To add an arrow to either end of your label, click one of the dashed-line squares in the Pipe Legend box, and choose an arrow style from the slide-out menu that appears. Repeat the process for the other end of the label; if the same arrow should appear on both ends of the label, check the box for Apply to Both. To close the slide-out menu, click the dashed-line square again.
3. If you prefer, you can adjust the text size or font with the options at the bottom of this window. The default selections are designed to be clearly readable.

Then, set the dimensions of your pipe marking with the Label Size box on the right side of the screen:

1. Choose your Auto Resize preference:
 - a. Fit label to text: automatically set your label's length to fit the text that you have entered
 - b. Fit text to label: automatically resize your text to fit the specified label dimensions
 - c. None: no automatic adjustments
2. Select the pipe diameter to use the recommended dimensions for a pipe of that size, or choose Custom Size to choose your own label size.

Finally, set special formatting options in the Formatting box on the right side of the screen:

1. Choose your label's background color in the dropdown menu. (The print color, either black or white, will be chosen automatically for standard compliance and readability.)
2. Choose Landscape (default) or Portrait orientation for your label.
3. If you need your label to be visible from multiple directions, select Pipe Wrap. By default, this makes a label that will be readable from below the pipe; for a label that will be read from above the pipe, select Top.

7.5.3 CREATING AN AMMONIA PIPE MARKER

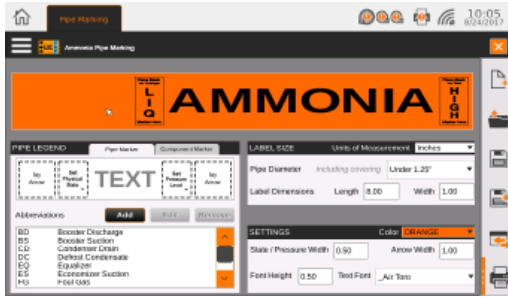

To create a new pipe or component label for ammonia-based refrigeration systems, using the IIAR Bulletin No. 114 styles, follow these steps:

1. Choose Ammonia Pipe Marking from the module menu in the toolbar.
2. Using the tabs at the top of the Pipe Legend box, on the left side of the screen, select whether you are making a pipe marker or a component marker. Then, set the printed content for the label:
 - a. To add an arrow to either end of an ammonia pipe marker, click one of the dashed-line squares in the Pipe Legend box, and choose an arrow style from the slide-out menu that appears. Repeat the process for the other end of the label; if the same arrow should appear on both ends of the label, check the box for Apply to Both. To close the slide-out menu, click the dashed-line square again.
 - b. To set the physical state or pressure levels for your marker, click the dashed-line boxes for those elements and make your selection from the slide-out menu that appears. Each slide-out menu also has a tab for printing these smaller labels separately. To close the slide-out menu, click the dashed-line square again.
 - c. Choose the equipment or system abbreviation, or the component name, from the list at the bottom of the Pipe Legend box. You can add custom items to the list with the Add button, or edit or remove selected items from the list with the Edit or Remove buttons.
3. In the Label Size box on the right side of the screen, select the pipe diameter to use the recommended dimensions for a pipe of that size, or choose Custom Size to choose your own label size.
4. The detailed size options in the Settings box will update automatically if you choose a pipe diameter; if you choose a custom size, you may need to adjust these options. You can also choose whether to print with an orange background or with a yellow background (to match existing labels in the older format).

7.5.4 CREATING AN ARROW WRAP

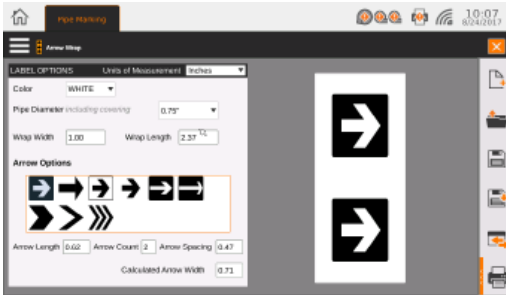

To create a band of printed arrows that can be applied around a pipe to show the direction of flow, follow these steps:

1. Choose Arrow Wrap from the module menu in the toolbar.
2. Choose the color of the band background. The arrow color, either black or white, will be automatically selected for standard compliance and visibility.
3. Select the diameter of the pipe you will be labeling; the program will automatically calculate recommended sizes and spacing. You can also manually set the wrap width, wrap length, arrow length, number of arrows, or spacing between arrows.
4. Set the arrow style by clicking on your choice in the Arrow Options box.

7.5.5 SAVING OR EXPORTING LABEL DESIGNS

To save a label, click the Save button in the menu along the right side of the screen (or choose Save Label from the Hamburger Menu). If the label has already been saved, the existing file will be updated; if not, you will be prompted to choose a file name and location.

To save the label as a new file, leaving the old version intact, click the Save As button in the menu along the right side of the screen (or choose Save Label As from the Hamburger Menu). You will be prompted to choose a file name and location.

To export a label for fine-tuning or other adjustments in the Label Designer module, click the Export button in the menu along the right side of the screen (or choose Export Label from the Hamburger Menu). You will be prompted to choose a file name and location, and you will be able to open the new file in the Label Designer.

7.5.6 PRINTING A LABEL

When you are ready to print, click the Print Settings button. Here, choose which labels you want to print, and how many copies of each. You can also check a Print Preview [here](#).

Click the Print button to start the new print job. If you are using the Kodiak's built-in screen for your label designs, you can also press the physical Print button on the front of your Kodiak to print one copy of the current label, using the current print settings.

7.6 Additional Options in LabelForge PRO Software

The PC version of the LabelForge PRO software includes the same label design modules as Kodiak's built-in version of the software. When using this software, you can access these modules from the software's Home Screen, which appears when you start the program. You can also return to the Home Screen by clicking the Home button in the top left corner of the program window.



- | | |
|-----------------------|---------------------|
| 1. Toolbar | 5. Live Chat Button |
| 2. Home Button | 6. Resources Button |
| 3. Recent Labels Menu | 7. Labeling Modules |
| 4. New Tab Button | 8. Support Buttons |

7.6.1 TOOLBAR AND ADDITIONAL OPTIONS

When you open a labeling module, a tab for that module will appear in the toolbar. Multiple modules can be open at the same time; you can switch between them by clicking the different tabs.

You can quickly return to a recent label design with the **Recent** menu, near the top left corner of the screen.

In addition to the label design modules already described in this guide, the PC version of LabelForge PRO includes these modules:

- **My Labels:** Browse the label designs that you have created in the Label Designer module, using thumbnail previews of the labels.
- **Resources:** Quickly visit the Graphic Products website to view How-To Videos or read a digital copy of this User Guide. You can also reach this section by clicking the Resources (lightbulb) button in the top right corner of the program window. An internet connection is required.

Along the bottom of the program window are support buttons, allowing you to quickly **Request Support**, start a **Live Chat** with an available representative, or offer your **Feedback** on the software to help guide future updates. You can also start a Live Chat by clicking the chat icon in the top right corner of the program window. An internet connection is required for these options.

7.6.2 PRINTING FROM PC

When printing from the PC version of LabelForge PRO, you will see a standard Print dialog window where you can select which printer to use, and how many copies of the design to print. You can control Kodiak's settings for this print job by selecting your Kodiak and clicking the Preferences button in this window.

8. Additional Functions

In addition to label design and printing, Kodiak's built-in interface offers several other functions.

8.1 Supply Status Utility

This utility shows the currently loaded supplies, and how much of each is remaining. Click the supply rolls on Kodiak's main toolbar to open this utility.

To print, Kodiak requires a label stock and two printing ribbons. This utility shows which supplies are present and how much of each is remaining. The catalog number for each loaded supply is also shown.

If you need to trim the edge of your label stock (after clearing a jam, for example) this utility also offers a Trim function, which will "print" a short, blank label, and cut it cleanly. The window also includes an option to cancel any current print jobs, or check your printing preferences.

8.2 Printing Preferences

These are the detailed controls for how your Kodiak will handle print jobs. When you load supplies, Kodiak will automatically adjust many of its settings to match those supplies, so you may only need to change these settings for unusual tasks.

The same overall settings are available whether they are accessed from Kodiak's built-in interface, or from the driver software on a PC.

8.2.1 PREFERENCES THROUGH KODIAK'S BUILT-IN INTERFACE

Click the printer icon on Kodiak's main toolbar to open these settings. You can also reach these settings through the label design modules.

This window has six tabs, with different options:

- **Basic Setup:** Choose the most common options, like landscape/portrait print orientation, cut options, or special effects like mirroring (flipping the design backward) or negative printing (switching the colors of the design). You can also choose a "preset" for all settings.
- **Speed/Heat:** If needed for troubleshooting, adjust the overall printing speed, and the individual heat adjustment for each print head.
- **Color:** If needed for troubleshooting or print quality, adjust the way Kodiak handles multi-color printing, shades of color, and overprinting (black/color) or base printing (white/color).
- **Alignment:** If needed for troubleshooting, adjust the printing offsets (horizontal and vertical) for each print head.

8. ADDITIONAL FUNCTIONS

- **Cut/Media:** If needed for troubleshooting, manually select the supply type and the feed or cut offsets.
- **Manage Presets:** Edit or create custom presets to quickly adjust all print settings.

If you access these controls from the main Kodiak toolbar (by clicking the printer icon) or through the Supply Status Utility, the window title will be shown as System Preferences. These will be the default controls used for all programs, but any changes you make here will not affect programs that are currently running.

If you access these controls through a program's individual options, the window title will be shown as Printing Preferences, and any changes will only affect print jobs for that session of labeling. The Manage Presets tab will not be present.

Negative printing, an effect available on the Basic Setup tab of this window, only uses the label stock and the ribbon loaded in position 1. Multi-color designs will be reduced to single-color with this effect.

The printing offsets, available on the Alignment tab of this window, should only be used when there is a serious misalignment. Ordinary printing will have a tolerance of up to 1/32 inch (under 1 mm) horizontally, and up to 1/16 inch (under 2 mm) vertically. If your Kodiak seems to be farther out of alignment, please contact Graphic Products for support by calling 800-788-5572 or visiting GraphicProducts.com.

8.2.2 PRINTING PREFERENCES ON PC

When accessing the Printing Preferences for your Kodiak from a PC, the orientation setting (landscape/portrait) will be the only option immediately available. Additional options for unusual needs, or for troubleshooting, can be reached by clicking the "Advanced..." button:

- **Cutter:** cut after each label printed, after a complete job, or not at all
- **Speed:** choose either 2 or 3 inches per second.
(For best quality, use the default of 2.)
- **Inverse:** switch the colors of the design. This effect only uses the label stock and the ribbon loaded in position 1. Multi-color designs will be reduced to single-color with this effect.
- **Mirror:** flip the design backward.
- **Ribbons Used:** for troubleshooting, manually control which ribbon and print head will be used.
- **Ribbon and Supply Colors:** when printing from third-party software, such as common word processors, manually select the loaded supplies to ensure the best print results.

- **Overprint and White Base Print:** when using black ribbon and another color, or white ribbon and another color, these options may be helpful for troubleshooting poor print quality.
- **Color Matching:** choose whether to use Best color matching (Kodiak uses the closest available match for any unavailable colors in your design) or Strict color matching (Kodiak will only print the colors that it can match exactly).
- **Dithering:** choose how Kodiak uses patterns of dots to approximate shades of color.
- **Heat Intensity Offsets:** for troubleshooting, adjust the heat used in the printing process.
- **Label Stock Format and following options:** for troubleshooting, adjust Kodiak's supply settings.
- **Stop Position and Horizontal/Vertical Offsets:** for troubleshooting, adjust Kodiak's printing offsets.

8.3 Networking Settings

To connect your Kodiak to a network, click the network icon on Kodiak's main toolbar. This utility shows the current network state, and a list of any available Wi-Fi networks.

To connect to a Wi-Fi network, select the desired network from the list, and click Connect. If a password is required, you will be prompted to enter it.

To connect to a wired (Ethernet) network, make sure that your Kodiak is physically connected to the network using a standard Ethernet cable. To set up the connection, the first step is to ensure the printer is running version 2.4.0 or higher. To check the version:

1. Select the home icon in the top left corner of the screen
2. Press the "?" button on the printer, located on the left of the screen
3. Select "Show Versions".

If your printer is not on version 2.4.0 or higher, please contact your Account Manager to request a USB drive with the update or it can also be downloaded from https://updater.graphicproducts.com/kodiak/Kodiak_Update_2.4.0.zip.

If downloaded using the link provided, be sure to unzip the file and save it to a USB drive. To update the printer, please follow the instructions provided in section 8.4.3 (UPDATER).

8. ADDITIONAL FUNCTIONS

Once confirmed the printer is running version 2.4.0 or higher, the IP address on the printer will need to be set. This can be done onboard the Kodiak by first pressing the Home icon, then navigating to **Settings** > **Networking** > **Ethernet**.

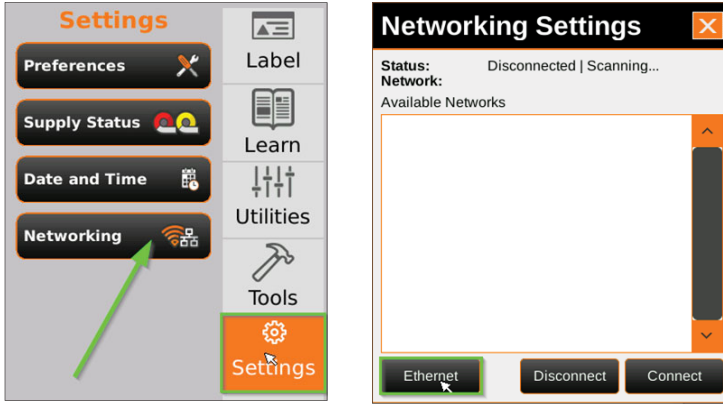

Next, set the IP address to Static or Dynamic, select Okay, and turn the printer off for at least 10 seconds before powering back on.

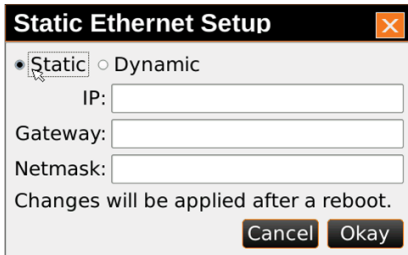

Once the printer boots back up, navigating to the Ethernet menu again will display the IP address as well as the MAC address.

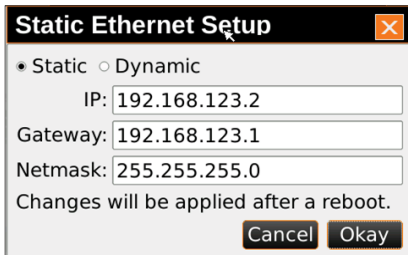

Next we'll want to install the DuraLabel Kodiak Driver v2.4.0 on the PC as if it were connected via USB. It is important that the printer is connected to the PC at this time, via an Ethernet connection. On your PC navigate to Devices and Printers, then select **Add a printer**.

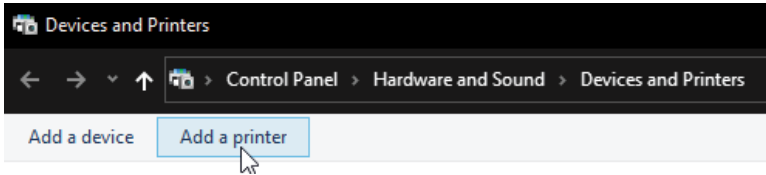

In the “Add a device” window, select “The printer that I want isn't listed”

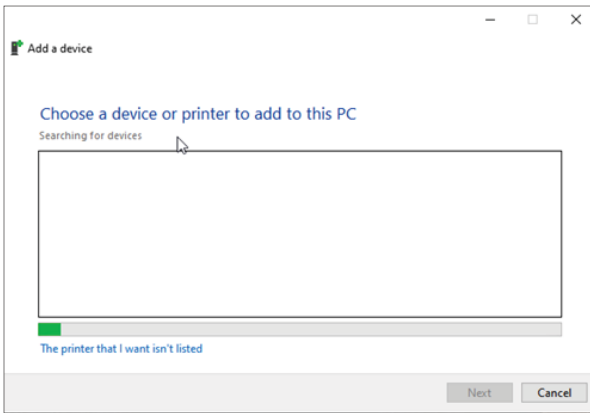

This will open a new window titled “Add Printer”, within this menu choose “Select a shared printer by name” and enter `http://[ipaddress]:631/printers/Kodiak` in the space provided then press “**Next**”.

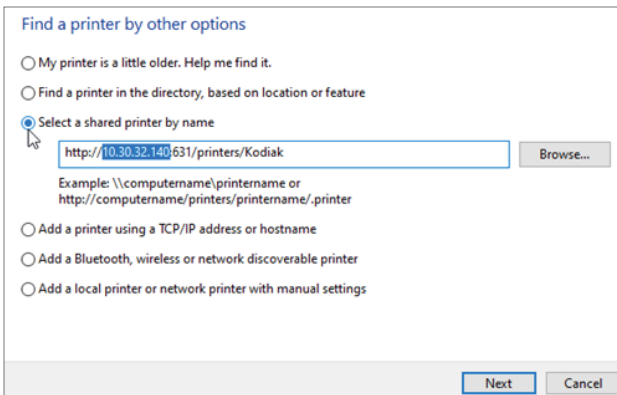

8. ADDITIONAL FUNCTIONS

The printer uses an onboard print server (CUPS) so it will need to be connected via Internet Printing Protocol, as opposed to creating a TCP/IP port.

When the computer recognizes connection with the printer, it will pull up a list of drivers. Select “Graphic Products, Inc.” as the manufacturer, then “DuraLabel Kodiak” as the printer, then press “OK”.

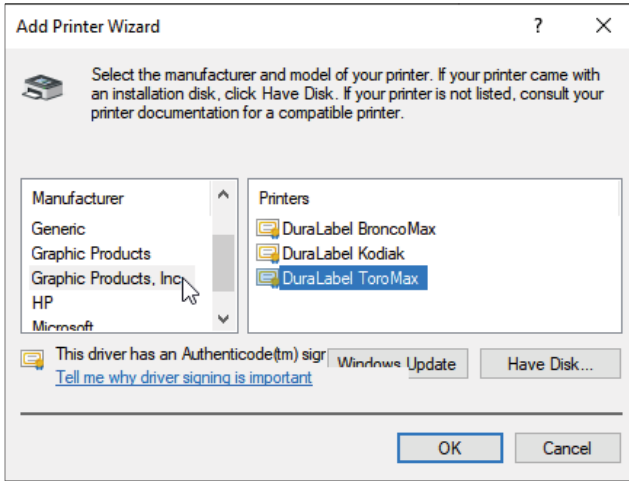

Once completed, you should see that
“You’ve successfully added the Kodiak on [http://\[ipaddress\]:631](http://[ipaddress]:631)”

8.4 System Utilities

These utilities are used for advanced functions or system troubleshooting, and can be found in Kodiak's Utilities menu.

8.4.1 DATABASE MANAGER

Several of the labeling modules in your Kodiak use internal databases to store and retrieve data for label printing. With the Database Manager utility, you can create a new database for a fresh start, import or export databases, or set up a network connection for using an external database with Open Database Connectivity (ODBC).

Start by selecting the database type with the dropdown menu. To create a new database, enter a name for the new database and press the Add Database button. To adjust, import, export, or copy an existing database or connection, select the existing database from the list, and use the buttons below the list or the editable fields to the right to fill in the appropriate information.

8.4.2 TOUCH CALIBRATION

If Kodiak's touchscreen seems to respond strangely, you can recalibrate it with the Touch Calibration utility. You will be asked to touch a series of targets on the screen; when each target has been touched, the calibration will be complete. Calibration may be repeated any number of times.

8.4.3 UPDATER

The Updater utility shows the currently installed software on your Kodiak. To navigate to the Updater press the Home Icon on the upper left of the screen, then on the right side of the screen select "Utilities", and then "Updater".

If an internet connection is available, the utility will check if any updates are available from Graphic Products and give you the option to download and install them.

If you have a USB flash drive, or other USB-connected storage device, with the software update files you can install them using the Updater. To do so, within the "Updater" menu press "USB", this will open a new window titled "Select a usb drive path". Within this window, select the USB storage device from the "Favorites" section, then on the right side of the selection plane choose the folder titled "DLKUPDATE", from here open the folder titled "Update", then press "Select". The printer will automatically go through the installation process, once complete turn the printer off for at least 10 seconds prior to powering it back on to complete the installation process.

While the Updater allows updates to Kodiak's existing software, which may allow for additional software from Graphic Products to be added in the future, no user software may be installed.

8. ADDITIONAL FUNCTIONS

8.4.4 USERS AND PASSWORDS

By default, Kodiak will not be locked; any person can use the system. To require a password, use the Users and Passwords utility to add an authorized user. Each individual user will have their own password, and there is no limit to the number of users that may be added.

Once an authorized user has been added, you can click the Lock button in this utility to lock the system. Any authorized user can also add or remove other authorized users in this utility.

If your Kodiak has been locked, but all user passwords have been lost or forgotten, contact Graphic Products for support at 800-788-5572 or at *GraphicProducts.com*.

9. Maintenance and Troubleshooting

If you have any questions on how to maintain or troubleshoot your Kodiak, contact Graphic Products for assistance by calling 800-788-5572 or visiting GraphicProducts.com.

9.1 Cleaning Your Kodiak

Periodic cleaning will help prevent jams, and keep your Kodiak running smoothly. If specks, spots, or streaks appear in your printed labels, clean the inside of the printer. If printed labels stick in the cutter opening or do not fall out on their own, clean the cutter.

Whenever cleaning your Kodiak, turn off the system and disconnect its power cord.

9.1.1 CLEANING INSIDE KODIAK

To clean the inside of your Kodiak, where the supplies are loaded, lift Kodiak's lid to its fully raised position.

1. Unlatch the two print heads, and lift them by their orange tabs until they hold in their fully raised positions. Slide the ribbon cartridges out of place, and put them somewhere safe. (If the cartridges have ribbon loaded, you can rest the cartridges upside-down to avoid getting dust on the ribbon.)
2. Unlatch the spring-loaded feed roller bar, and let it rise out of the way. Turn your roll of label stock by hand to rewind any supply that is still feeding through the printer.
3. Using a pre-moistened cleaning swab or a soft cloth with some isopropyl alcohol, wipe the underside of each print head, paying attention to the green strip of heating elements and the shiny metal feeding guide.
4. Under the print heads, wipe the rubber rollers clean. Then wipe the rubber roller in the raised feed roller bar.
5. Check the adjustable supply guides for any adhesive build-up, especially under the small white rollers, and clean them as well.

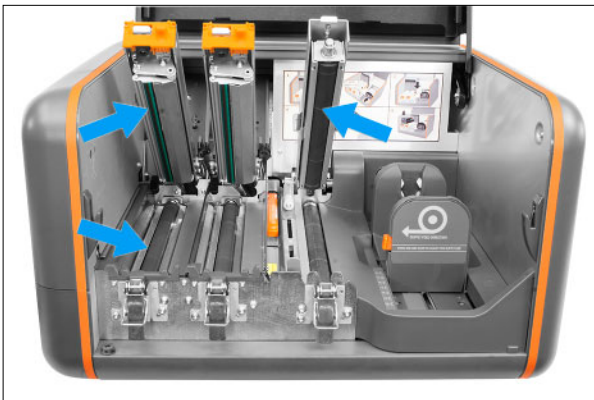

9. MAINTENANCE AND TROUBLESHOOTING

9.1.2 CLEANING THE CUTTER

The best way to reach the cutter for cleaning is from the front of the printer. When cleaning the cutter, be sure that your Kodiak is powered off and unplugged; the cutter blade is sharp.

1. Raise Kodiak's touchscreen to its highest position. Behind the screen, just above each end of the cutter slot, you'll see two Philips screws. These screws hold the cutter faceplate on; remove the two screws, and set them somewhere safe.
2. Press the cutter faceplate down to release it, and put the faceplate somewhere safe. This will expose the cutter blades. Be careful; while the faceplate is removed, the cutter motor will not engage, but the blade is still sharp.
3. Using a pre-moistened cleaning swab or a soft cloth and some isopropyl alcohol, remove any built-up adhesive from the blades.
4. Replace the cutter faceplate by sliding it up into place, and re-inserting the two screws.



After cleaning your Kodiak, give it a minute or two to air-dry. Then, load supplies and you'll be ready to print again.

9.2 Troubleshooting

9.2.1 ERROR MESSAGES

Kodiak can detect many of the possible problems that can arise during printing, and will show an error message on the screen to let you know what has happened and how to resolve the problem.

If one of these errors interrupts printing, you will have several options for how to continue:

- **Cancel All Jobs:** Stop printing, and cancel any other print jobs that were waiting.
- **Cancel Job:** Stop printing the current sign or label, but continue with the next print job.
- **Retry Job:** Start the current print job over, and continue with the next print job.
- **Ignore:** Close the error message temporarily, leaving all printing paused.

You can open the error message again by clicking the printer icon in Kodiak's main toolbar. (This may be necessary if you choose the Ignore option when the message appears.)

9.2.2 CLEARING A JAM

If label stock becomes jammed during printing, you will need to open Kodiak's lid and remove the jammed material. Follow these steps:

1. Raise Kodiak's lid, and unlatch and raise the feed roller bar and the two print heads.
2. Locate the jam. Ordinarily, label stock should move smoothly from the supply roll, under the feed roller bar, between and under the adjustable supply guides, under each of the print heads, and out through the cutter.
3. Remove the jammed material. This may require you to turn rollers by hand; this will not damage the printer. If material has jammed inside the cutter mechanism, you may need to remove the cutter faceplate; if so, be careful of the blade, which is sharp. (See the instructions for cleaning the cutter.)
4. Reload supplies. You may need to cut off a section of supply, if it is too wrinkled to feed smoothly through the system. This can typically be done with scissors.

For a perfectly clean cut, after supplies have been loaded, you can use the Trim function in the Supply Status Utility.

9. MAINTENANCE AND TROUBLESHOOTING

9.2.3 REPEATED “JAM” ERROR MESSAGES

If you see repeated errors about a jam in the printer, but there does not seem to be any supply jammed anywhere in the system, the sensor near the center of the cutter may be blocked by dust. This typically occurs when Kodiak has not been cleaned for some time. Follow these steps to clear the sensor:

1. Raise Kodiak's lid. This will allow light to shine through the cutter and make the sensor easier to find.
2. From the front of the system, raise the screen to its highest position.
3. Look through the cutter slot to find the small gap, located at the center of the slot. This gap is the location of the sensor.
4. Remove any obstruction from the sensor gap. Often, this is best done with a gas duster or “canned air.” If a small piece of label stock has become lodged over the sensor, you may need to use tweezers to remove it.
5. Close Kodiak's lid and try printing again.

9.2.4 UNEXPECTED COLORS IN PRINTED LABELS

Kodiak allows you to design labels with a variety of colors, but can only print using the supplies that you have loaded. If your design includes a color that your supplies can't provide, Kodiak may print your design with its best match of the available supply colors. If you would prefer to leave those elements unprinted, follow these steps:

1. Open the Printing Preferences window in your design program, or open the System Preferences window by clicking the Printer icon on the Kodiak main toolbar.
2. On the Color tab, set the Color Matching option to “Print Only If Color Matches.”

If you need the elements to be printed in their designed colors, you will need to load the appropriate supplies.

10. Specifications

Kodiak specifications are subject to change without notice.

10.1 Capabilities

- Create, edit, save, and print label designs with internal software
- Connect to a Wi-Fi network to download updates and use database information
- Lock system with user passwords
- No user software may be installed

10.2 Printer Body

- Dimensions: 17.4" W x 11.8" T x 19.5" D (496mm x 441mm x 301mm)
- Weight: about 42 lbs (about 20 kg), excluding supplies

10.3 Print System

- Type: Thermal Transfer
- Print Heads: 2
- Print Speed: 2 inches per second
- Resolution: 300 dpi
- Max. Print Width: 8.4 inches
- Max. Print Length: 100 inches

10.4 Interface

- Touchscreen size: 9" (diagonal)
- Buttons: Print, X (Cancel), ? (Help)

10. SPECIFICATIONS

10.5 Communication and Data Storage

- Communications: USB 2.0 (front: 2x USB-A, back: 2x USB-A, 1x USB-B), Ethernet, Wi-Fi USB Adapter
- Data Storage: roughly 2 GB internal storage available; 4 GB external USB flash drive

10.6 Power Requirements

- Input: 100-240 VAC (50-60 Hz), 8A
- Different AC power cords available for worldwide usage

10.7 Environment

- Operating Temperature: 50°F - 104°F (10°C - 40°C)
- Operating Humidity: 30% - 85%, non-condensing
- Storage Temperature: -4°F - 140°F (-20°C - 60°C)
- Ventilation: keep ventilation holes clear

10.8 Label Stock

- Type: Continuous, Black Mark, or Die-Cut
- Width: 4" minimum, 10" maximum

10.9 Ribbon Supply

- Type: Premium Resin
- Width: up to 8.66"
- Capacity: up to 361'

10.10 System Requirements for Kodiak Driver and LabelForge PRO Software

- Windows 7 or Windows 10 operating system

11. Certifications

11.1 Radio Compliance

11.1.1 UNITED STATES FCC

This equipment has been tested and found to comply with the limits of a Class A digital device, pursuant to Part 15 of the FCC Rules. Operation is subject to the following two conditions: (1) This device may not cause harmful interference, and (2) this device must accept any interference received, including interference that may cause undesired operation. These limits are designed to provide reasonable protection against harmful interference when the equipment is operated in a commercial environment. This equipment generates, uses, and can radiate radio frequency energy, and if not installed and used in accordance with instructions may cause harmful interference to radio communications. Changes and modifications could void the user's authority to operate this equipment.

11.1.2 INDUSTRY CANADA

This device complies with Industry Canada license-exempt RSS standard(s). Operation is subject to the following two conditions: (1) this device may not cause interference, and (2) this device must accept any interference, including interference that may cause undesired operation of the device.

Le présent appareil est conforme aux CNR d'Industrie Canada applicables aux appareils radio exempts de licence. L'exploitation est autorisée aux deux conditions suivantes: (1) l'appareil ne doit pas produire de brouillage; (2) l'appareil doit accepter tout brouillage radioélectrique subi, même si le brouillage est susceptible d'en compromettre le fonctionnement.

11.2 Standard Conformity

Kodiak conforms to the following US, Canadian and European Radio, Safety, and EMC standards.

11.2.1 US/CANADA

FCC 15.107:2017 Class A, FCC 15.109:2017 Class A, FCC 15.109(g):2017 Class A, FCC 15.207:2017, FCC 15.225:2017, ICES-003:2016 updated April 2017 Class A, RSS-210:2016

11. CERTIFICATIONS

11.2.2 EUROPE

EN 300 330 V2.1.1:2017, EN 301 489-3 V2.1.1:2016, EN 55032:2012/AC:2013 CLASS A, EN 55024:2010, EN 61000-3-2:2014, EN 61000-3-3:2013.

The product herewith complies with the requirements of Radio Equipment Directive (RED) 2014/53/EU, Low Voltage Directive 2006/95/EC, EMC Directive 2014/30/EU, and WEEE and ROHS Directive 2002/95/EC.

11.2.3 SAFETY

EN 60950-1:2006, IEC 60950-1:2005 (2nd Edition)

Radio Intentionally Emitting Radio Waves:

- a. frequency band(s) in which the radio equipment operates: 13.56 MHz
- b. maximum radio-frequency power transmitted in the frequency band(s) in which the radio equipment operates: -17.2dBuA/m

11.3 Printer Disposal/Recycle



The following symbol  of a crossed-out wheeled bin indicates that the Kodiak printer must be disposed of properly and not treated as general waste. Incorrect disposal could have a negative impact on human health and the environment. For more information on the correct disposal/recycling of this printer, please contact Graphic Products at 800-788-5572.

12. Third-Party Software

This is a comprehensive list of third-party software and libraries used by Kodiak, organized by their license type. The licenses can be found in the Licenses file in Kodiak's Manuals folder. While the provided software can be updated through the built-in Update utility or through software provided by Graphic Products, no additional user software can be installed on Kodiak.

GNU General Public License version 2 (GPL-2)

- obexftp: <https://sourceforge.net/projects/openobex/files/obexftp>
- openobex: <https://sourceforge.net/projects/openobex/files/openobex>
- obexpushd: <https://launchpad.net/ubuntu/+source/obexpushd>
- obexd: <https://www.kernel.org/pub/linux/bluetooth>
- rtl8188eu: <https://github.com/lwfinger/rtl8188eu>
- mtd-utils: <http://git.infradead.org/mtd-utils.git>
- mysql odbc: <https://dev.mysql.com/downloads/connector/odbc>
- psqlodbc: <https://ftp.postgresql.org/pub/odbc/versions/src>
- poppler: <http://poppler.freedesktop.org>
- cups-filters: <http://openprinting.org/download/cups-filters>

GNU General Public License version 3 (GPL-3)

- zint: <http://sourceforge.net/projects/zint>
- samba: <https://www.samba.org/samba/download>

GNU Lesser General Public License version 2.1 (LGPL-2.1)

- unixODBC: <http://www.unixodbc.org>
- qt-gstreamer: <https://gstreamer.freedesktop.org/src/>
- libqxt: <https://github.com/mnuttl/libqxt>
- CuteLogger: <https://github.com/dept2/CuteLogger>

12. THIRD-PARTY SOFTWARE

GNU Library General Public License version 2 (LGPL-2)

- freetds: <https://github.com/FreeTDS/freetds>

GNU Free Documentation License version 1.3 (FDL-1.3)

- Qt Spreadsheet Example: <http://doc.qt.io/qt-5/qtwidgets-itemviews-spreadsheet-example.html>

MIT License (Expat)

- QtXlsx: <http://qtxlsx.debao.me>
- ijs: <http://www.openprinting.org/download/ijms/download>
- lcms: <https://sourceforge.net/projects/lcms/files/lcms>

Custom Licenses

- libsqlite3odbc: <http://www.ch-werner.de/sqliteodbc>
- openjpeg: <https://github.com/uclouvain/openjpeg>

THIS PAGE INTENTIONALLY LEFT BLANK

THIS PAGE LEFT BLANK INTENTIONALLY

THIS PAGE LEFT BLANK INTENTIONALLY



800-788-5572 | [GraphicProducts.com](https://www.GraphicProducts.com)

©2017, 2022 Graphic Products, Inc. All Rights Reserved