

DuraLabel[®] PRO

==== *User's Guide* ====



Graphic Products, Inc.

1-800-788-5572

Local: 503-644-5572

www.DuraLabel.com

www.GraphicProducts.com

E-mail: info@GraphicProducts.com

WARRANTY

The Graphic Products DuraLabel PRO is warranted to be free from defects in materials or workmanship for a period of two years from the date of purchase with the following exception: The DuraLabel PRO print head is warranted to be free from defects in materials and workmanship for a period of one year from the date of purchase. Within this period, Graphic Products, Inc. will, at its sole option, repair or replace any components which fail in normal use. Such repairs or replacement will be made at no charge to the customer for parts or labor, provided that the customer shall be responsible for any transportation cost. This warranty does not cover equipment or parts which have been misused, altered, neglected, carelessly handled, used for purpose other than those for which the printer was manufactured or damages resulting from unauthorized service.

Note: Repairs have a 90 day warranty. If the unit sent in is still under its original warranty, then the new warranty is 90 days or to the end of the original warranty, depending upon which is longer.

The Warranties and remedies contained herein are exclusive and in lieu of all other warranties whether express, implied or statutory, including any liability arising under any warranty of merchantability or fitness for a particular purpose, statutory or otherwise. This warranty gives you specific legal rights, which may vary from state to state.

In no event shall Graphic Products be liable for any incidental, special, indirect or consequential damages, whether resulting from the use, misuse or inability to use the product for any reason including defect. Some states do not allow the exclusion of incidental or consequential damages, so the above limitation may not apply in all areas.

Graphic Products retains the exclusive right within all warranty periods to repair, replace the product or offer a full refund of the purchase price at its sole discretion. Such remedy shall be your sole and exclusive remedy for any breach of warranty.

For further service information, please contact your Graphic Products representative at 1-800-788-5572 or www.graphicproducts.com.

GETTING STARTED

Minimum System Requirements

Operating System: *Windows 2000 SP4, Windows XP SP2, Windows Vista*

Memory: *128 MB RAM*

Additional Requirements: *IT Administration*

Supplies

The ribbon and various print media for the DuraLabel® PRO have been optimized for compatibility and print quality. Only authorized supplies from Graphic Products will print correctly in the DuraLabel® PRO.

Prepare Printer

Instructions for unpacking, loading supplies and connecting your printer are located in the **Printer Manual** (in electronic form). There is also an instructional video included on the CD, that shows you how to load supplies. Please read and follow those instructions carefully before continuing.

NOTE: *To view the electronic version of the printer manual you will need a corresponding document viewer (PDF or DOC). A suitable viewer is included on the installation CD - Adobe Acrobat Reader.*

*Please contact us for all your labeling needs. From standardized to custom labels, we're ready to provide the labeling supplies you need.
Call 1-800-788-5572 today to get your labeling problems solved.*

INTRODUCTION

Welcome... And congratulations on the purchase of your new *DuraLabel[®] PRO Thermal Transfer Printer!* We've included this guide to get you printing as quickly as possible.

In this guide you'll find information on setting up your printer, configuring your software, and creating custom labels. We know that all topics cannot be addressed in any document and are ready to answer your questions. If you have any questions or concerns, make sure to give us a call! *Graphic Products, Inc. 1-800-788-5572*

CONTENTS

Warranty	pg. 1
Getting Started	pg. 2
Minimum System Requirements	pg. 2
Supplies	pg. 2
Prepare Printer	pg. 2
Load Printer	pg. 4
Printer Ribbon Parts	pg. 4
Load Ribbon	pg. 5 - 9
Printer Inside Parts	pg. 10
Load Label Stock	pg. 11 - 13
Tape Guide Install Instructions	pg. 14 - 16
To Use Tape Guides	pg. 14
Connect Printer	pg. 17
Insert Installation CD	pg. 17
Install Using USB Cable	pg. 18 - 19
Install Using Parallel Cable	pg. 20 - 23
Configure Driver	pg. 24 - 27
Configure Windows 2000/XP/Vista	pg. 24
Continuous Vinyl Printing Instructions	pg. 25
Die-Cut Label Instructions	pg. 25
Black Mark Label Instructions	pg. 26
Cut Labels in Intervals	pg. 26
Adjust Print Speed	pg. 27
Adjust Darkness	pg. 27
Label Creation	pg. 28
Use Templates	pg. 29
Set Up Microsoft Word Document	pg. 29
Select Printer	pg. 29
Change Page Setup	pg. 31
Orientation	pg. 32
Label Design	pg. 33
Text	pg. 33 - 34
Graphics	pg. 35 - 36
Symbols	pg. 37 - 38
Barcodes	pg. 39 - 40
Sequencing	pg. 41 - 44
Import from Excel	pg. 45 - 49
Cleaning & General Maintenance	pg. 50 - 53
Print Head	pg. 50
Cutter	pg. 51
Cleaning The Cutter From The Inside	pg. 52
Platen Roller	pg. 53
Troubleshooting	pg. 54 - 59
Specifications	pg. 60

LOAD PRINTER

Printer Ribbon Parts

Rear Spring-Loaded Hub
for Ribbon Supply Spindle

Rear Hub (for Flange-side of Spindle)
for Ribbon Supply Spindle

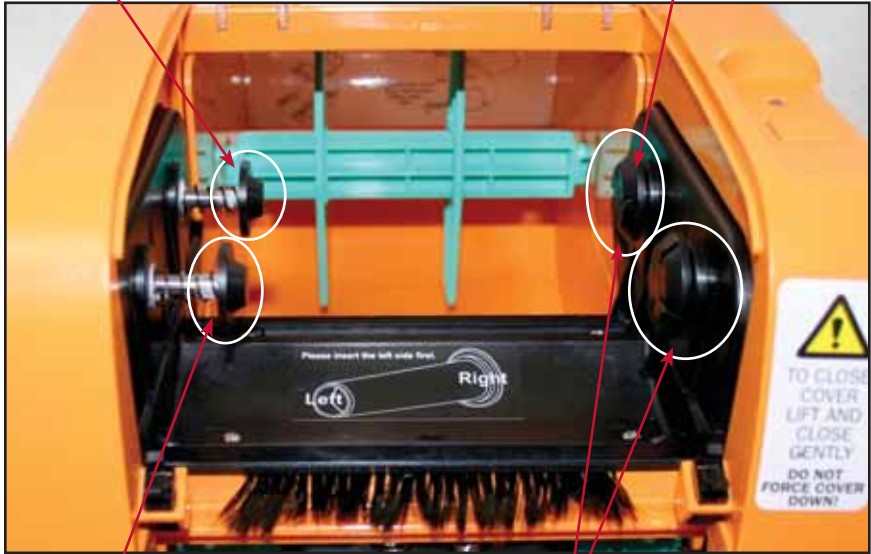

Front Spring-Loaded Hub
for Ribbon Rewind Spindle
(with paper core)

Front Hub (for Flange-side of Spindle)
for Ribbon Rewind Spindle

Flange of Ribbon Spindles insert on the right side, when facing the front of the Printer.

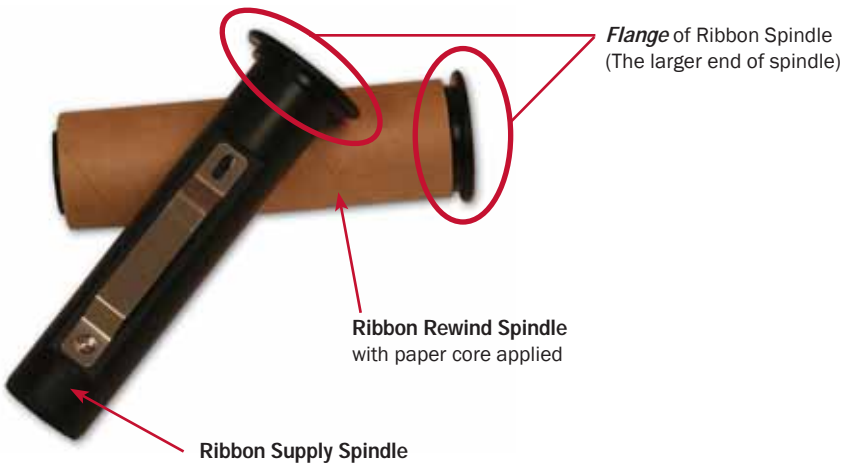

Load Ribbon

IMPORTANT! Always turn OFF the printer when loading supplies. Always wait at least 5 seconds before turning ON the power.

The ribbon and various print media for the DuraLabel[®] PRO have been optimized for compatibility and print quality. Only authorized supplies from Graphic Products will print correctly in the DuraLabel[®] PRO.

Turn the power OFF first!

1. Open the Ribbon Mechanism Cover by pressing down and in on the Ribbon Mechanism Cover to unlatch, then lift up and back to open.



Fig. 1 Press down and in to unlatch



Fig. 2 Lift up and back to open

For loading 4.3" ribbon supply, please follow "To Load 4.3" ribbon supply" instructions (page 5). For loading 2.5" ribbon supply, please follow "To Load 2.5" ribbon supply" instructions (page 6).

To Load 4.3" ribbon supply

2. With flange of the spindle on the right side, apply 4.3" Ribbon Supply to the Ribbon Supply Spindle with the Ribbon Supply leader extended over the top and towards the back.
3. Slide the Ribbon Supply on the Spindle until it touches the Flange of the Spindle.

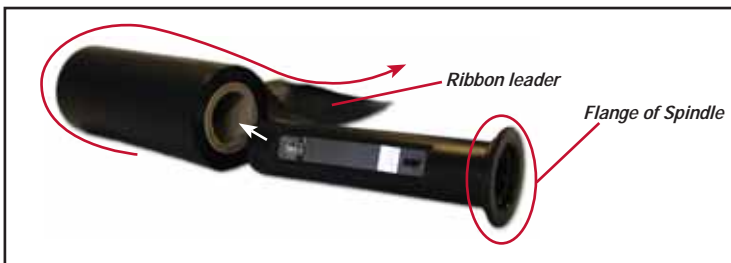

Fig. 3 Correct ribbon application for Spindle

4. Apply the provided paper core onto the front Ribbon Rewind Spindle.
5. Skip to Step 6, section Load Ribbon Continued. (See page 7, section "Load Ribbon Continued")

To Load 2.5" ribbon supply

2. With the flange of the spindle on the right side, apply 2.5" Ribbon Supply to the Front Ribbon Spindle with the Ribbon Supply leader extended over the top and towards the back.

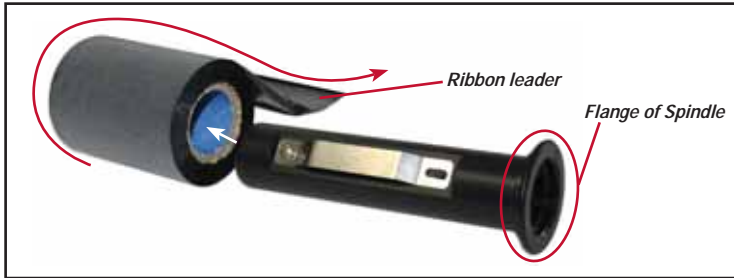

Fig. 3 Correct ribbon application for Spindle

3. Align the 2.5" Ribbon Supply in the center of the ribbon spindle using the measurement marks.



Fig. 4 Ribbon Supply (2.5") centered on Ribbon Supply Spindle

4. Apply the provided 2.5" paper core onto the front Ribbon Rewind Spindle and center it using the measurement marks.



Fig. 5 Paper core (2.5") centered on Ribbon Supply Spindle

5. Skip to Step 6, section Load Ribbon Continued. (See page 7, section "Load Ribbon Continued")

Load Ribbon Continued - For All Ribbon Supply Sizes

The ribbon loading process is the same for all sizes of ribbon for Steps 6 - 12 of section "Load Ribbon Continued". Pages 7-9, Fig. 6, 7, 8, 11, 12, 13, & 14 illustrate 4.3" ribbon supply.

6. Apply the Ribbon Supply Spindle to the Rear Hub, with the Ribbon Supply leader dropped down.



Fig. 7 Ribbon Supply (4.3") Spindle inserted at Rear Hubs

Fig. 6 Ribbon Supply (4.3") spindle being inserted at Rear Hubs

7. Place the Ribbon Rewind Spindle with the paper core on the Front Hubs, by inserting the left side of the Spindle first, fitting it onto the Front Spring-Loaded Hub. Then fit the right side of spindle which has the flange onto the right Hub.

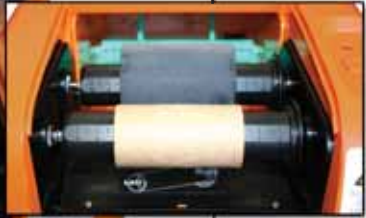

Fig. 9 Ribbon Supply (2.5") Spindles loaded and aligned with each other

Fig. 8 Ribbon Rewind Spindle with paper core (4.3") being applied to the Front Spring-loaded Hub

8. Open the Printer Cover by pulling forward the Printer Cover Release Levers on the sides of the printer.



Fig. 10 Printer Release Lever being pulled forward

9. Grab the Ribbon Supply leader that is hanging down.



Fig. 11 Ribbon Supply (4.3") being pulled down and underneath

10. Pull it towards you and underneath the Ribbon Mechanism and Print Head, up to the Front Hub.

NOTE: The ribbon should rotate with ease as you unroll it. The dull side of the ribbon should face down towards the label stock.



Fig. 12 Ribbon Supply being pulled up to the Ribbon Rewind Spindle

11. Tape the entire width of the end of the Ribbon Supply leader to the paper core of the Ribbon Rewind Spindle.



Fig. 13 Ribbon Supply (4.3") taped to Ribbon Rewind Spindle

12. Roll the Ribbon Rewind Spindle (*top side of spindle moving away from you*) to secure the Ribbon Supply and eliminate wrinkles, fingerprints or flaws.



Fig. 14 Ribbon Supply (4.3") rolled tight with dull-side facing out (dull-side of ribbon should face label stock)

Your Ribbon Supply should be loaded.

Printer Inside Parts

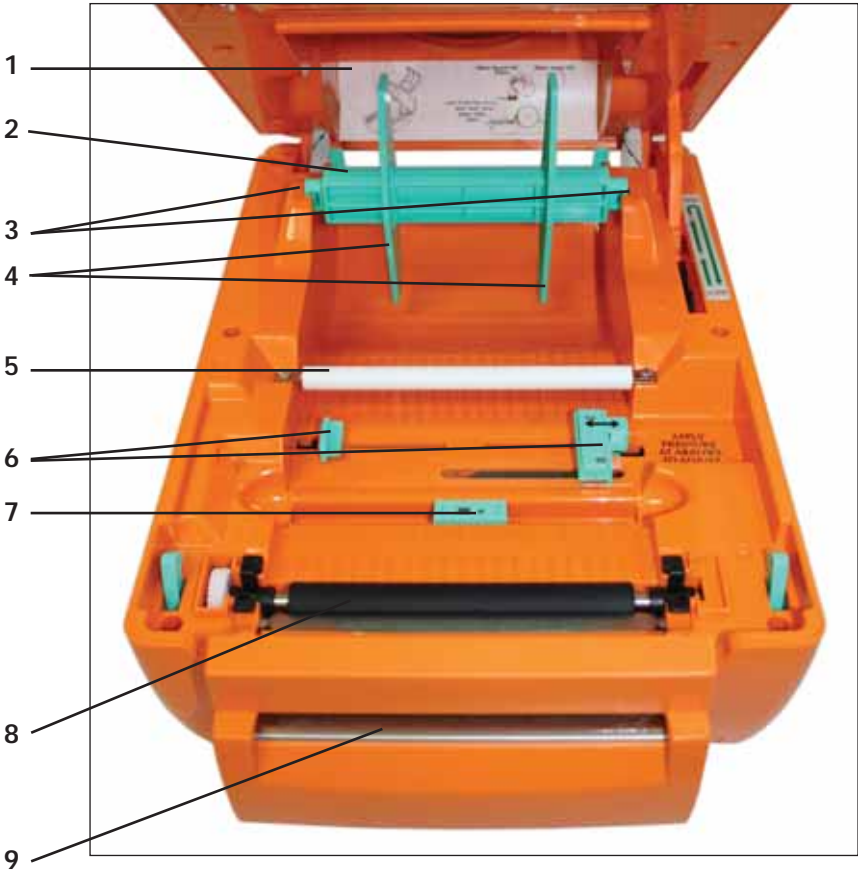

Fig. 1 Inside of Printer with Ribbon Mechanism open in an upright position

1. Supply Loading Diagram
2. Label Supply Roll
3. Label Roll Mounts
4. Fixing Tabs
5. Teflon Bar (*white*)
6. Adjustable Label Guides (*turquoise*)
7. Media Sensor/Black Mark Sensor (*turquoise*)
8. Platen Roller (*black*)
9. Printed Label Opening

Load Label Stock

IMPORTANT! Always turn OFF the printer when loading supplies. Always wait at least 5 seconds before turning ON the power.

Turn printer power OFF first!

1. With the Ribbon Mechanism still in upright position. Load Label Stock onto Label Supply Spindle and center it using the Fixing Tabs on each end to secure supply.
2. Place loaded Label Supply Spindle in the Label Roll Mount slots with the Label Stock extending over the top of the roll and towards the front of the printer.



Fig. 2 Loaded Label Supply Spindle set in Label Roll Mount slots



Fig. 3 Label Stock loaded in the correct direction

3. Lead the Label Stock underneath the white Teflon Bar, over the black Platen Roller and through the Printed Label Opening, leaving at least 1/2" of supply extended out.



Fig. 4 Label Stock loaded correctly with printable surface faced up and liner faced down

4. Move the Adjustable Label Guides to hold the Label Stock in place.



Fig. 5 Label Stock under white Teflon Bar and held in place by Adjustable Label Guides

5. Close the Printer Cover by slowly lifting back then gently down until it latches closed as described in the supply loading diagram located inside the top cover at the back of the printer.



Fig. 6 Diagram located on back, right side of Printer, when the Printer Cover is open



Fig. 7 Printer Cover closed with Ribbon Mechanism Cover open

6. Close the Ribbon Mechanism Cover by pressing down and in until it latches closed.



Fig. 8 Press down and in to close



You printer is loaded and ready!

TAPE GUIDE INSTALL INSTRUCTIONS

To Use Tape Guides

The following are instructions on how to install Tape Guides. Tape Guides are required for 1/2" label stock and shrink tube sizes 3/8" and smaller. Larger vinyl and shrink tube are adequately held in place by the Adjustable Label Guides.

1. Load shrink tube or 1/2" label stock into the DuraLabel PRO and thread it through the cutter. (See pages 10-13 of the User's Guide, section "Load Label Stock")

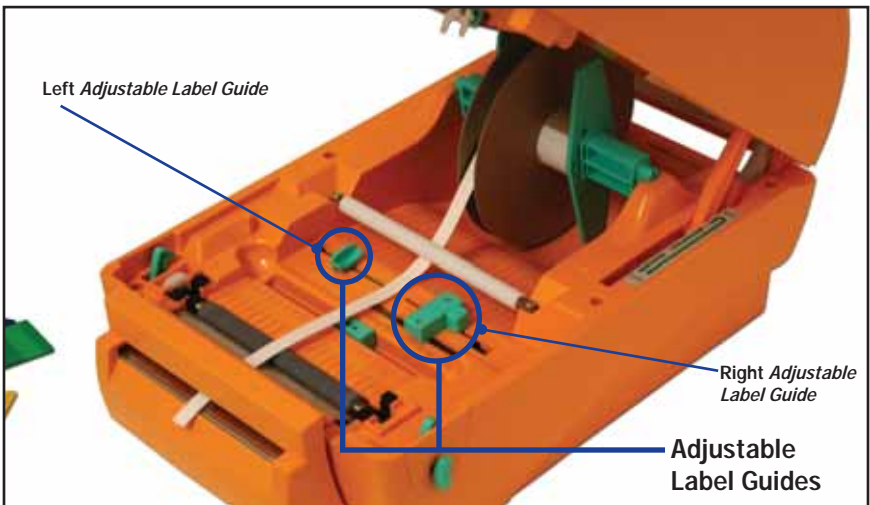
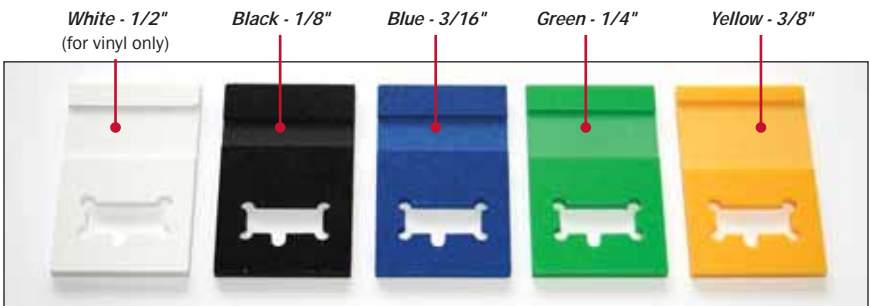

Fig. 1 Shrink tube supply (3/16" size) loaded

2. Find the corresponding Tape Guide to match the size of shrink tube or label stock which is loaded.



3. When facing the front of the printer, hold the Tape Guide in hand with the smooth, flat-side facing up and the cut-out opening oriented on the left side.

NOTE: Move the Adjustable Label Guides inwards, leaving about a 2 inch gap for easy installation.

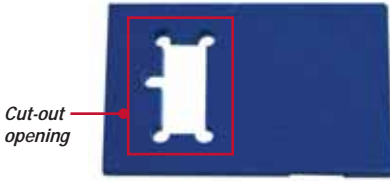

Fig. 2 Smooth, flat-side



Fig. 3 Grooved-side



Fig. 4 Tape Guide with smooth, flat-side up, grooved-side down with cut-out opening on the left side

4. Slip the cut-out opening over the left, smallest Adjustable Label Guide, but do not press all the way down into place.



Fig. 5 Tape Guide being fitted over the left Adjustable Label Guide

5. Align the labeling supply to fit underneath and in the grooved section of the Tape Guide. This allows for optimal alignment and smooth dispensing.



Fig. 5 Tape Guide not completely pressed down with shrink tube aligned under grooved section of Tape Guide

6. Press the Tape Guide down completely into place.

NOTE: You may need to move the labeling supply slightly for the supply to move freely under the grooved section of the Tape Guide.

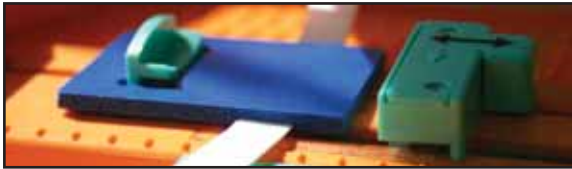

Fig. 6 Tape Guide pressed down into place and over shrink tube supply

7. Move the Adjustable Label Guides towards each other until the Tape Guide touches the right Adjustable Label Guide and the Adjustable Label Guides cannot move any further. This aligns the shrink tube/label stock over the Media Sensor and secures Tape Guide in place.



Fig. 6 Shrink tube fitted underneath and in the grooved section of the Tape Guide



Media
Sensor

- Fig. 7 Adjustable Label Guides pressed together, holding the Tape Guide in place with shrink tube aligned properly over the Media Sensor and fitted in grooved section of the Tape Guide.

Close the printer cover and you're ready to print!

IMPORTANT! You must have administrative rights in order to install driver.

NOTE: Find out your Windows version by right-clicking on the **My Computer** icon (located on your desktop). Select the **Properties** option. Your Windows version is located under the **System** heading. Make sure you have installed the latest updates from Microsoft, including service packs.

CONNECT PRINTER

Connect the power supply from the DuraLabel® PRO to an electrical outlet. Connect the USB or Parallel Cable from the DuraLabel® PRO to your PC. Power ON the DuraLabel® PRO.

To the Right:

A Found New Hardware notification may appear (only if using a USB cable) in the bottom right hand corner of your desktop after plugging in all components and powering ON the printer.



Insert Installation CD

Before inserting the Installation CD, please refer to the instructions for the type of cable being used. When connecting with a USB Cable, please follow the “Install Using USB Cable” instructions pages 18-19. For Parallel Cable, please follow the “Install Using Parallel Cable” instructions pages 25-26.

If you plan to print RTK or Arc Flash labels:

After you've installed the drivers, insert the **Industrial Labeling Suite CD** into your computer drive. **Install** the **Right-To-Know & Arc Flash Label Software** on your computer. When the installation screen opens, you can click **More Information** to see more info on the installation process or simply click **Automatic Install** to begin.

To use the RTK or Arc Flash Label Software, the print driver and the DuraLabel® PRO itself must be set up. See page 25-26 of the User's Guide for “Die-Cut Label” & “Black Mark Label Instructions.”

Install Using USB Cable

The following instructions (pages 18-19) are only for those using a USB Cable. Skip to page 20 of the User's Guide if installing manually.

IMPORTANT! You must have administrative rights in order to install driver.

A Found New Hardware dialog box may appear. If so, select **No, not this time**.



Insert the DuraLabel® PRO CD into the CD-ROM drive. Select **Install the software automatically** and click **Next**. (This step may run automatically.)



When prompted to continue, click **Continue Anyway**.



A dialog box will appear showing the progress of the files being copied. It will close after copying is complete.



A Found New Hardware Wizard dialog box will appear after completion. Click **Finish** to exit and close the screen. A Found New Hardware notification box may appear.



Skip to page 24 of User Guide, section "Configure Windows 2000/XP/Vista Printer Driver."

Install Using Parallel Cable

The following instructions (pages 20-23) are only for those using a Parallel Cable.

IMPORTANT! You must have administrative rights in order to install driver.

Insert the Installation CD into the CD-ROM drive. (If you encounter a dialog box that says you must have .NET Framework, follow the instructions in the box.)

NOTE: If the CD does not automatically run, go to **Start >> My Computer** and double-click on the DLP icon.

A "Found New Hardware" dialog box may appear. If so, select **No, not this time**.

To begin, click **Install Driver** at the top right corner of your DuraLabel® PRO Installation CD screen.



Click **Yes** to accept the default directory, "C:\DL Pro"

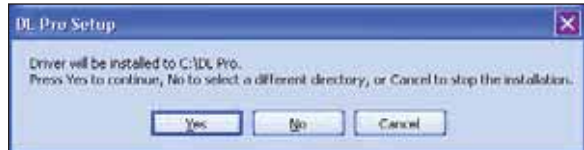

Click, **OK** to run **Add Printer Wizard**.



An **Add Printer Wizard** window should have appeared on your screen; click **Next**.



Select either **Local** or **Network** for your printer driver. If you select Local, make sure the “**Automatically detect and install my Plug and Play printer,**” is unchecked.



Check **Use the following port**, and select **LPT1** and click **Next**.



Select **Graphic Products DuraLabel PRO** and click **Next**.

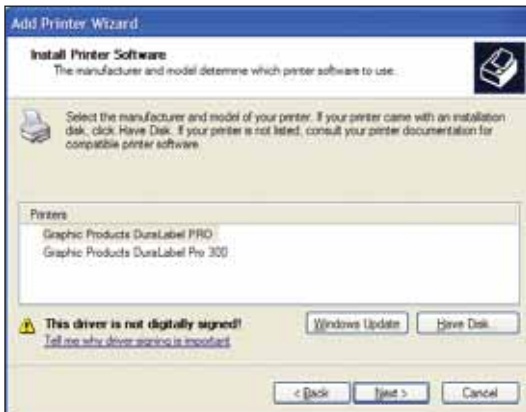

IMPORTANT! If you had previous Seagull Scientific drivers installed, press **Cancel** then reload the cd and refer to the inside cover of the QuickStart Guide for instructions on how to “Upgrade Drivers”.



Keep existing printer name as **Graphic Products DuraLabel PRO** and select **Yes** if you wish for it to be set as your default printer, then click **Next**.

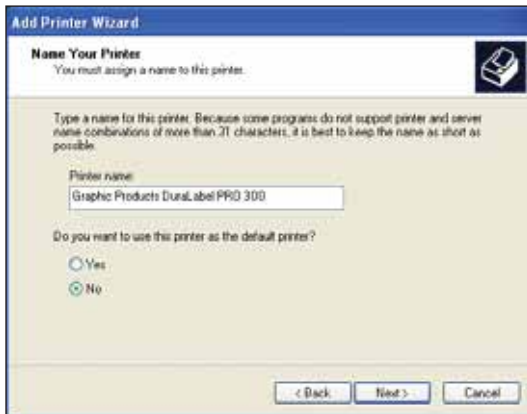

Decide if you would like to share the printer with other network users, then click **Next**.



Select **No** to “Do you want to print a test page,” then click **Next**.



Make sure your settings are correct. If so select **Finish**, otherwise select **Back** and change to the correct settings.

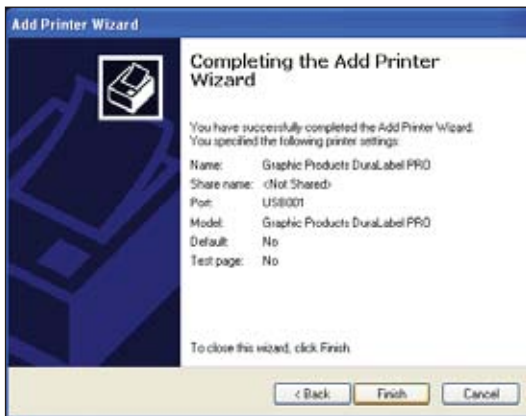

A dialog box will appear regarding Hardware Installation, click **Continue Anyway**.



Your driver should be installed and you should be ready to set up for printing.

Continuous Vinyl Printing Instructions

To set the cutter, select the **Stock** Tab. Set the **Media Settings** “Type” to **Continuous**. In order for the automatic cutter to cut after each label, under **Media Handling** next to “Post-Print Action,” select **Cut** and then next to “Occurrence” select **After Every Page**. These settings may be later adjusted to your specifications in the Printer Properties as you are printing your labels. Select **Apply** on the bottom of the Printing Preferences window.

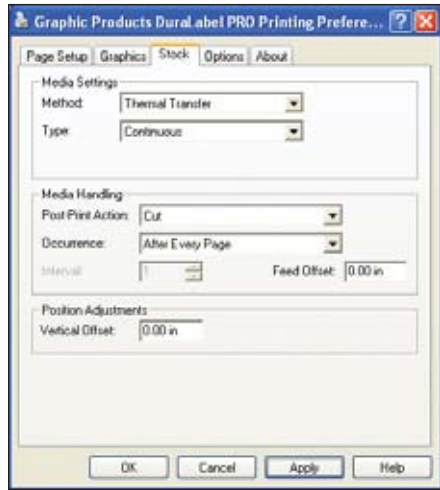

Die-Cut Label Instructions

Die-Cut Label Calibration

In order to print die-cut labels, the label stock needs to be calibrated. To do so, with the printer power OFF, hold the FEED button down while turning ON the printer. Release the FEED button while it blinks red. Once this process is complete follow the "Driver Settings for Die-Cut Labels" to change the driver settings.

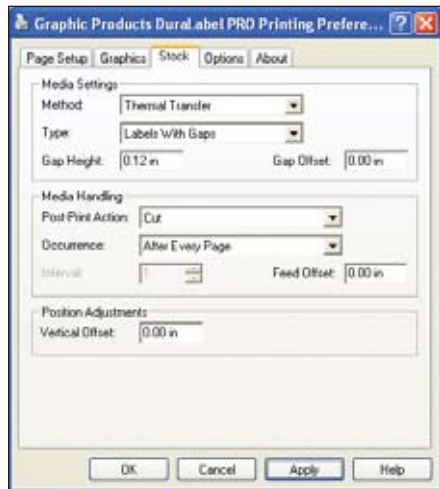

Driver Settings for Die-Cut Labels

For die-cut labels with the 1/8" gap, the settings on the **Stock** tab should be as follows: “Method” set to **Thermal Transfer**, the “Type” set to **Labels With Gaps**, “Gap Height” set to **0.12** (default) and “Gap Offset” to **0** (default.)

Black Mark Label Instructions

Black Mark Calibration

In order to print labels with black marks, the label stock needs to be calibrated. To do so, with the printer power OFF, hold the FEED button down while turning ON the printer. Release the FEED button while it blinks green-amber.

The LED color will flash as follows: red (5 blinks) amber (5 blinks) then green and amber will blink alternately. Once this process is complete follow the "Driver Settings for Black Mark Labels" to change the driver settings.

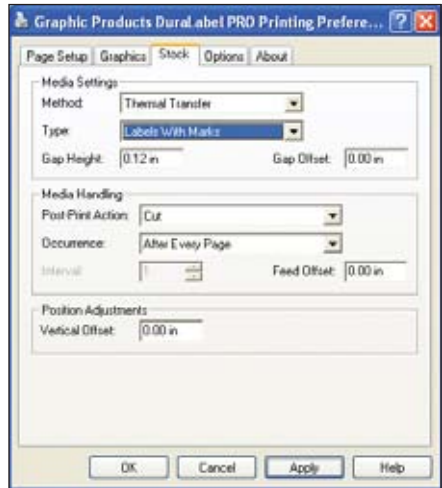

Driver Settings for Black Mark Labels

For black mark labels with the 1/8" black mark, the settings on the **Stock** tab should be as follows: "Method" set to **Thermal Transfer**, the "Type" set to **Labels With Marks**, "Mark Height" set to **0.12** (default) and "Mark Offset" to **0** (default.)

Cut Labels in Intervals

To cut labels in intervals, you may do so by setting the "Occurrence" to **After Specified Interval** under the **Stock** Tab. Set the Interval to the number of labels needed. Click **Apply** to save your settings.



Adjust Print Speed

Print Speed is adjustable from 2.0" to 3.0"/sec. Choose the print speed from the **Option** Tab by clicking on the arrow to the right of the "Print Speed" box.



Adjust Darkness

The Darkness is adjusted from 0 to 15 in increments of 1. From the **Option** Tab, change the darkness by clicking on and dragging the slider on the "Darkness" bar.

The **Graphics Format** settings should not be adjusted. Leave them at **Automatic**.

When finished with your settings, click **Apply** then click **OK**.

Your driver is now set up and you are ready to create your labels!

NOTE

In certain situations, you may need to change the print settings to optimize the DuraLabel[®] PRO for printing with certain ribbons or a specialty tape supply. Generally, higher speeds require higher densities. If the ribbon wrinkles, lower the darkness. Increase the Darkness to prevent fading. Decrease to prevent wrinkling.

Recommended Darkness Settings for Ribbon: (Print Speed set at 2)

Ribbon	Chemical	Standard Black	White	Red	Blue	Green	Orange	Shrink Tube/RTK	Die-Cut Labels
Darkness	9-15	4-8	4-8	4-8	4-8	4-8	4-8	6-8	10 (speed 3 & with standard black ribbon)

LABEL CREATION

Before We Begin...

This documentation describes how to make standard labels. If you are printing RTK labels, please see the RTK software documentation. The RTK documentation was installed on your computer at the same time the RTK software was installed.

The examples in this tutorial were tested with *Microsoft Word 2000*. Some variations may occur with different versions of *Word*, or with different word processors, but the basic principles will be the same. The DuraLabel® PRO is designed to work with any currently supported *Windows* software, and should work with the software packages that you already have installed on your computer.

All portions of this tutorial assume that the DuraLabel® PRO has been properly installed and is connected in the online mode. Please see the installation guide for more information before proceeding with this tutorial.

Label Creation With Your Word Processor...

Many have invested in high-end word processing software that is never used to its full potential. Today's word processors come packed with features and capabilities that far surpass the average user's needs. Advanced page layouts, graphic manipulation and printing options are only the beginning of what most word processors have to offer.

The DuraLabel® PRO operates off of a standard *Windows* printer driver that makes the printer accessible from a wide variety of software packages. Many printers will only work with expensive, proprietary software that is often buggy and overpriced. With the DuraLabel® PRO you will be able to use the software that you are familiar with, and get the most out of an investment you've already made.

In this tutorial we will show you how to use *Microsoft Word* to create and print custom labels and signs. If you have further questions concerning your software package, or label creation in general, please refer to the contact information on the back cover of this tutorial.

Use Templates

We have provided a variety of templates on the DuraLabel® PRO to help get you printing labels in no time. To get to these templates, you should **install from the start-up screen on your Installation CD**. This should only take a minute or two.

Click on **Install Templates and Symbols** on the start-up screen, then follow the instructions. The Templates will install to your **Desktop** on your computer.

After installation is complete, templates and symbols will be located in a folder called **Symbols** in your **DLP Templates and Symbols** folder located on your **Desktop**.

Now, when you want to use a template, just open **Microsoft Word**. Select **Open** then browse the **DLP Templates and Symbols** folder. There are a variety of templates for you to choose from, all of which are setup to print correctly on the DuraLabel® PRO. Just customize the label to your specifications and **PRINT!**

Set Up Microsoft Word Document

Once you open a new or existing document, you must change the paper size and margins. Word processors will default to 8.5" x 11", but changing these settings is generally very simple. The steps are outlined for *Microsoft Word* below:

1. Select Printer

Before you make any changes to the page layout you must first select the DuraLabel PRO as your printer. The word processor communicates with the selected printer driver to determine if margin and other settings are within the printers limits. To select the DuraLabel PRO click on the **File** menu, then the **Print** selection; which will bring up the print dialog: In the print dialog simply locate the pull-down selection and choose **Graphic Products DuraLabel PRO** as your printer. Click **OK** to continue.

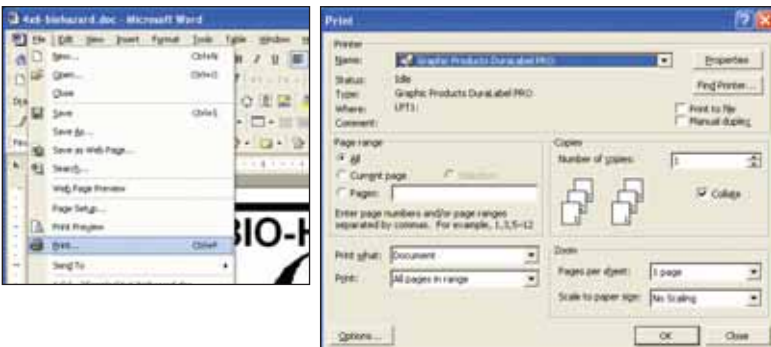

To Change the Automatic Cutter Setting:

You can change the automatic cutter settings without going back into the printer driver.

Go to **File >> Print** , then click on the **Properties** button next to DuraLabel PRO.



Choose the **Stock** tab.

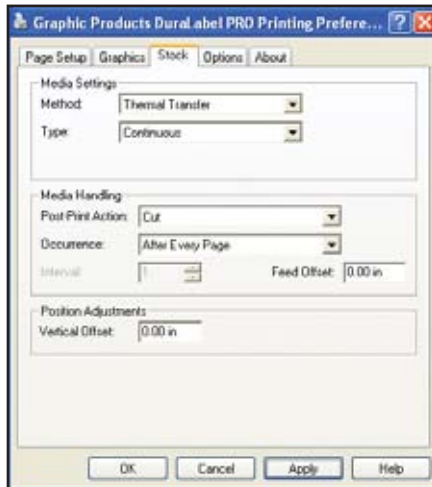

A new dialog will open which allows you to change the cutter options.

If you do not want to cut between labels select **None** under Media Handling next to “Post-Print Action.” If you want to cut between labels, select **Cut** and next to “Occurrence” select **After Every Page**.

Click **Apply** then click **OK** in the **Properties** dialog box to save your new settings.

2. Change Page Setup

Click on the **File** menu, then the **Page Setup** selection.

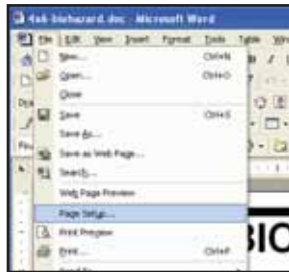

Now click the **Margins** tab. Set all of your margins and edges to **0**. This will allow you to print on the entire area of your tape. Set the orientation to desired layout. Depending on your operating system, the orientation may be on another Tab.

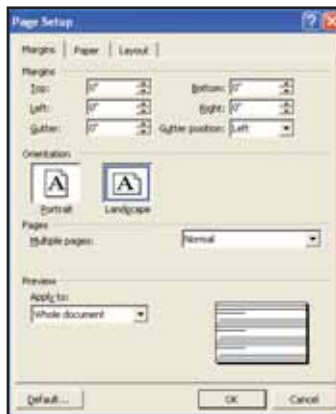

Select the **Paper Size** tab. Set your paper size to the size of the label you wish to create. Either the width or the height should match the width of the tape supply you have loaded in the machine.

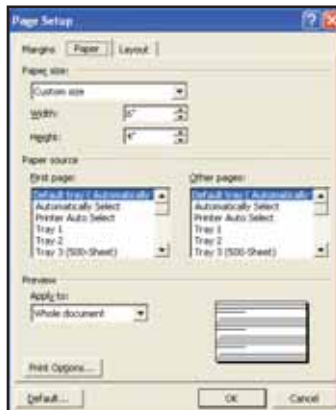

Orientation

Create the label with the width and height of the Label. If the **width** of the label is the width of the tape installed in the printer, then set the **orientation** to **Portrait**. If the **height** of the label is the width of the tape installed in the printer, set the **orientation** to **Landscape**.

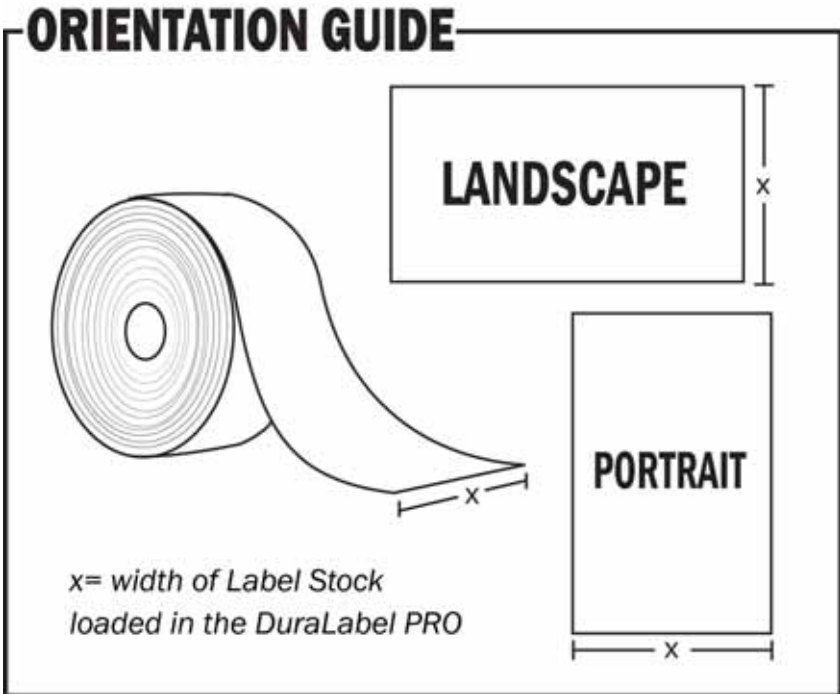

Click **OK** to commit your changes. With your document properties set correctly you're ready to move on to label creation!

LABEL DESIGN

Text

Working with text for label creation is only slightly different from working with text in a normal document. In a document, text can be treated as a whole: formatting, layout and design can be universal. With a label, each section of text has to be handled separately.

Titles will have to be moved and adjusted, portions of text will have to be moved around independently and with more detail than in a normal document. In a document it is sufficient to have most text single or double-spaced; in a label you may want to move text only a few millimeters, or several centimeters.

Text Boxes

A text box may be formatted or positioned anywhere on the document. The box can have borders and can be filled with different colors, or it can have no borders and be transparent. All of these features make text boxes ideal for label creation. In *MS Word* add a text box with the following steps. Click on **Insert >>> Text Box**.

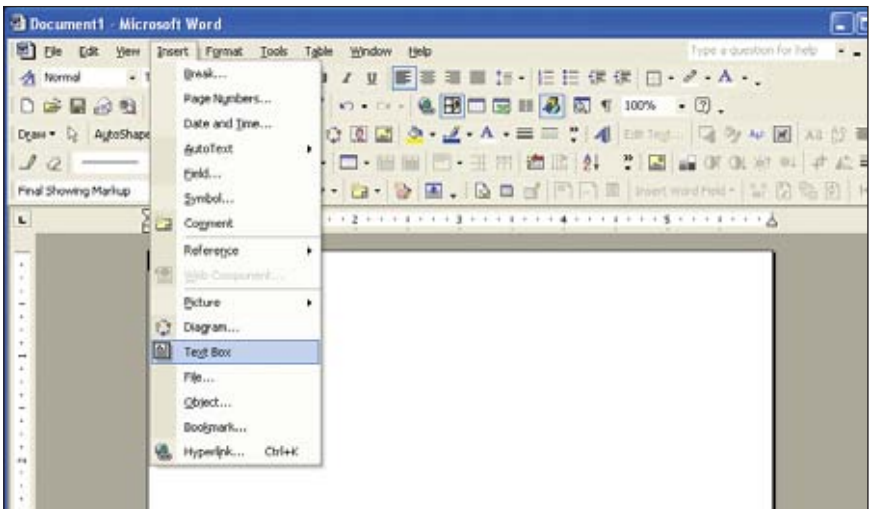

Next, holding down the left mouse button, drag (*in the document window*) the square handles on the border of the text box until it is the desired size. You can scale and position text boxes with ease. The squares only appear after a text box is created. While creating, the cursor is a cross.

Format the text inside the box to any size and style, then position the box for the desired layout. Initially, the text box will have a border around it. To get rid of the border, double-click the text box. When you do this, the **Format Text Box** dialog will appear. Click the **Colors & Lines** tab. Click the **Color** drop-down menu under **Line** and select **No Line**. Then, click **OK**, and the border will be gone.

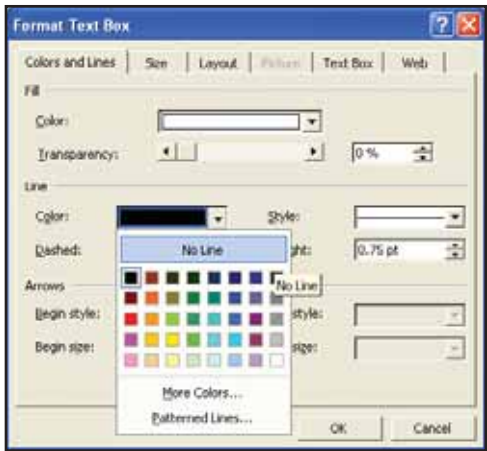
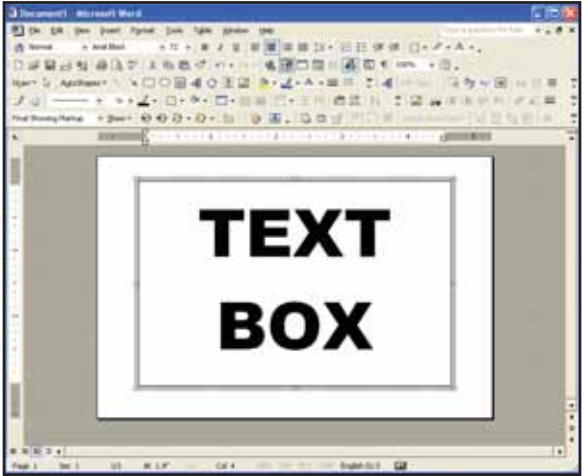

NOTE

If you choose not to use **text boxes** for your text, you will still be able to print your label, but formatting problems may prevent you from getting the results you desire.

Information on the text box tool is available through your word processors help file.

Consult the **help file** for more detailed information on using text boxes.

Graphics

Drawing Tools

Many word processors have built-in drawing tools. You can use these tools to enhance the look of your labels. Designs can be as complex as you desire, but colors should be kept to black and white. Black and white will give you the best contrast, and the best printing output. Actual print color depends on the ribbon and vinyl loaded in the DuraLabel® PRO and is unaffected by the colors shown on your computer screen.

Images

To insert a picture into a *Word* Document, first **create a new text** box so you can insert the picture into the text box (*this allows the image to be moved.*) Once you've created a text box, select it by clicking inside the box, then click on **Insert >>> Picture >>> From File**, then choose the location of the file you desire to insert. Insert symbols by browsing to the **Symbols** folder on the DuraLabel® PRO CD. The picture is automatically placed in your *Word* document. Change the size by clicking and holding down on the corner of the box, while dragging it to the desired size.

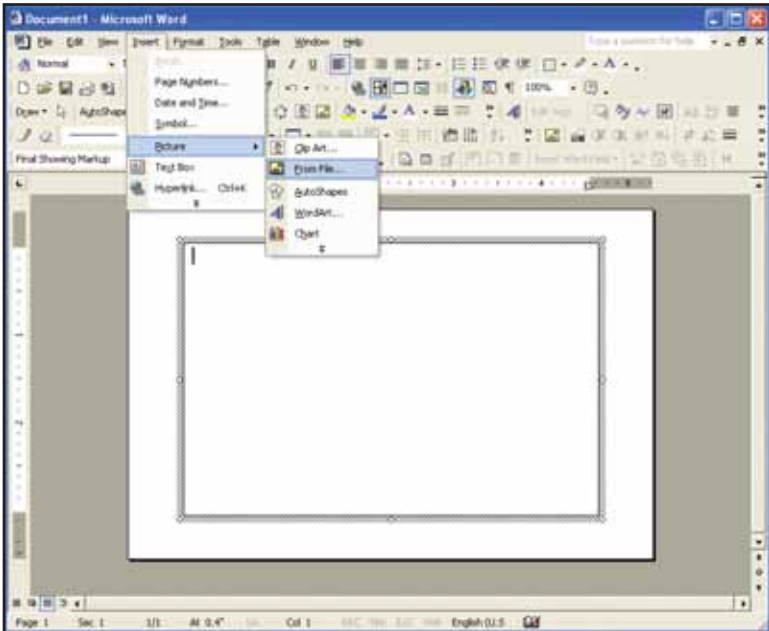

You can insert other objects, graphics, and clip art from the same pull-down menu. When working with images it is important to remember the type of printer you are using. Images should be formatted so that your printing output matches the capabilities of the printer. The DuraLabel[®] PRO is designed for label creation, and has a monochromatic output (*meaning it can only print one color at a time.*)



With *Word* it is easy to make your images print in monochrome. Once the image is inserted into the document simply double-click on it and select the **Picture** tab. Under the **Image Control** section choose the **Color** pull-down menu and select **Black and White**. Your image will be instantly converted to a format that the DuraLabel[®] PRO can handle.

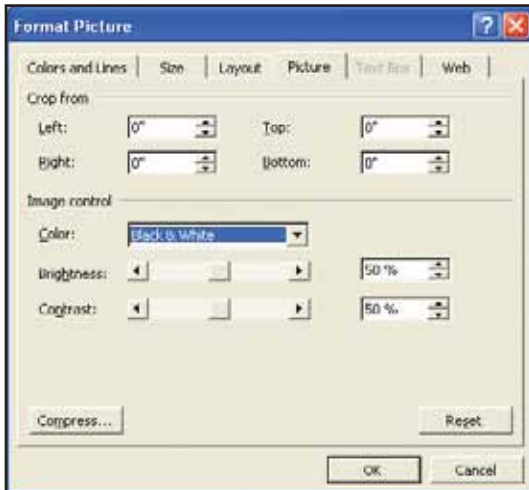

Symbols

Symbols can be used on labels and signage to get your point across visually. When safety is a concern, it is important to have a language that is universal, and symbols accomplish just that.

For your convenience we've included more than 400 ready-to-use symbols, which are divided by category, on your DuraLabel® PRO CD. Just choose a symbol, insert it into your document, then print a visually appealing and informative label or sign. To view or print a list of all of the included symbols, browse to the Symbols folder on the CD. A PDF of all of the symbols in their respective categories is included in that folder.

Inserting Symbols

Insert symbols into an Microsoft Word document by clicking on **Insert >>> Picture >>> From File**. From that window, browse to the **Symbols** folder. If you have already installed the symbols from the CD (*they automatically install when you install the templates*), there will be a folder on your **Desktop** called **DLP Templates and Symbols**.

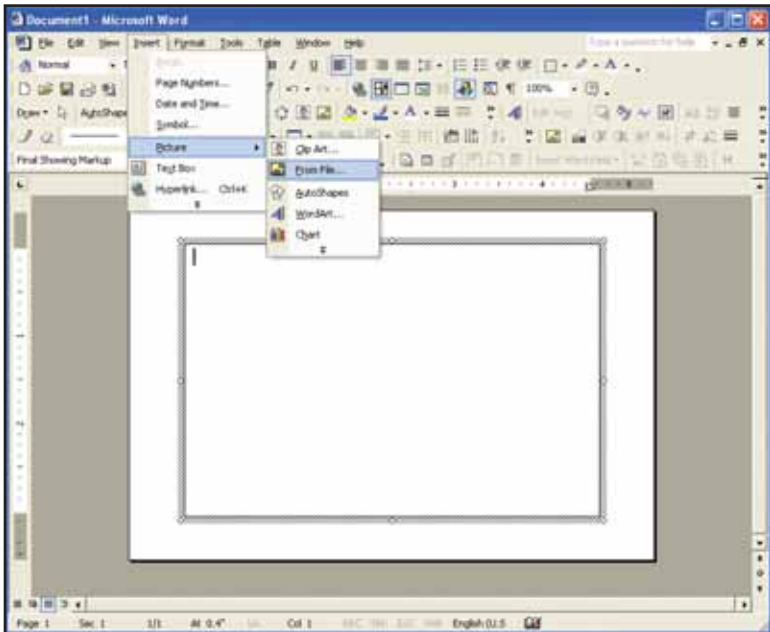

The **symbols folder** is located inside the **DLP Templates and Symbols** folder.

Just choose the symbol you want from the categorized folders and insert into your document.

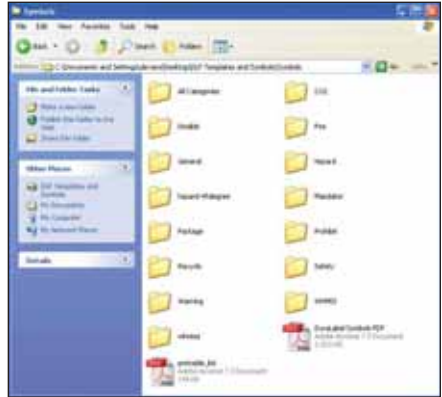

Once your symbol is inserted into your text document, you can resize and move it to your desired layout.

Helpful Hint:

When trying to determine the size of your label or the size of the symbol you place on it, take into consideration the distance from which the sign or label will be viewed. You should make the symbol large enough that a viewer can comprehend it from as far away as deemed necessary.

NOTE

To Install the Symbols, insert the DuraLabel® PRO CD into your CD drive. When the startup screen appears, simply click the "Install Templates and Symbols" button, follow the on screen directions, and they will be automatically installed on your Desktop in the DLP Templates and Symbols folder. You can browse to that folder at any time to use the symbols or templates.

Barcodes

The barcode program we have included easily displays and prints barcodes from your Windows based word processing program. Install the *dBest Barcode Package* from the CD. When the CD startup screen appears upon inserting the CD in the CD drive, simply click on **Install *dBest Barcode Package*** and follow the on-screen instructions.

You can get all of the technical information about the included barcodes in the **Barcode Font Library >>> Programmers Guide** once the barcode software is installed. **Activate the *dBest Barcodes* Toolbar Template in Microsoft Word**

NOTE

The dBest Barcode Font Library supports 11 standard barcode styles: Code 39; Extended Code 39, Interleaved 2/5; Code 128; UCC 128; Codabar; UPC A and E formats, EAN 8 and 13 formats and PostNet. Each barcode style supports a different set of ASCII characters and is used for different situations or industrial applications. For instance: Code 39 supports uppercase characters, numeric characters and a few incidental characters while Interleaved 2/5 only supports numeric data, but does so in a compressed format. You should choose which barcode style to use in your application based upon the type of data you need to support or by other requirements placed upon your application.

1. Open the *MS Word* document in which you would like to create your barcodes.
2. Go to the top menu bar in *MS Word*. Select: **Tools >> Templates and Add-Ins**
3. A window will appear showing a list of

Global Templates and Add-Ins.

Click the **ADD** button and locate the *bcfonts.dot* in the bcfont main directory (C:\bcfont\msoffice\).

4. Select the *bcfonts.dot* and Click **OK**.
The *bcfonts.dot* file should appear in the **Global Templates and Add-Ins** list with the check box selected. If the box is not selected, then select it.

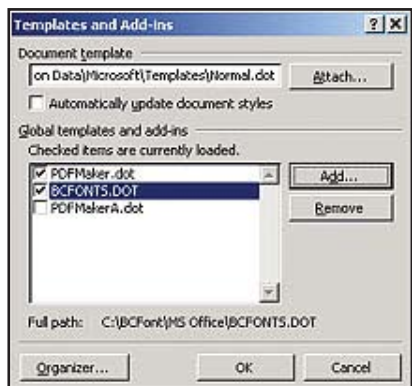

5. Click **OK** to exit, returning to your document. The toolbar should appear within your work space.

If you do not see the *dBest Barcodes* Toolbar, you need to run the toolbar as a macro. Refer to the following:

1. Go to the top menu bar in *MS Word*. Select: **Tools >> Macro >>Macros**
2. A window will appear with a list: **Macros in: All Active Templates & Documents.**
3. Select: **Barcode Toolbar** and click **Run**

*NOTE: To force the toolbar to display every time you start Word, go to **Start >>> Search >>> For Files and Folders** and type in *BCFONT*. Click **OK**. Once the file is found, right click it and choose "copy." Next, go to the *C:/Program Files/Microsoft Office/Office/Start up/* folder, right click inside of the folder, and choose "paste."*

Using the *dBest Barcodes* Toolbar

The Barcode String is where you can type in the characters for the barcode you wish to create. After typing in the new barcode information, hit the Enter key to save the information, or it will revert back to the previous Barcode String. The Barcode String pull down menu displays previous strings that have been used.

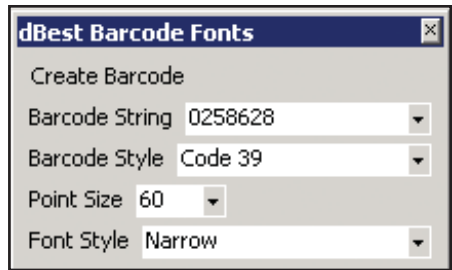

The **Barcode Style** pull down menu allows you to select a variety of barcode styles supported by the *dBest Barcodes Font Library*.

The **Point Size** pull down menu determines the size of the barcode. You can enter custom sizes by typing in the size and hitting the enter key to save the size.

The **Font Style** pull down menu allows you to select six different font widths for each supported **Barcode Style**: three high density and three normal density widths.

Creating a Barcode Using the *dBest Barcodes* Toolbar

Once you have selected the necessary fields on the toolbar, you are ready to create a barcode to place within your *MS Word* document.

1. Place your cursor where you want the barcode to appear. (*You can do this inside a text box if you wish.*)
2. Go to the *dBest Barcodes* Toolbar. Click **Create Barcode**. The barcode will appear where you placed your cursor.

Sequencing

How to do Number Sequencing using Word and Excel.

Sequencing is most commonly used to increment a numeric value to be used in labels for wire wrapping. You can use of an Excel spreadsheet template as well as a *Word* template (included on your installation CD):

1. Open an existing template from the DuraLabel CD or start a new *Word* document.
2. Because Excel uses Pixel measurement instead of inches, you will want to set this to match in *Word*. Go to **Tools** menu >>> **Options** to bring up the property sheet for *Word*. Click on the **General** tab, and locate the option to change the unit of measure. See Fig. 1. Change it to **Point** as this is the same as pixel (1" = 72 points, 2" = 144 points, 3" = 216 points, 4" = 288 points, etc.)

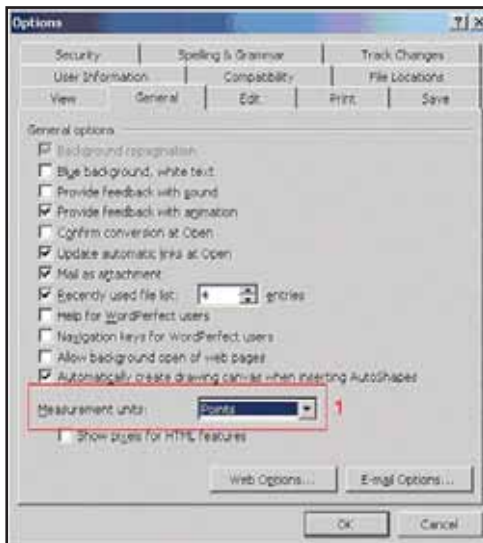

Fig. 1

3. Next go to **File** >>> **Page Setup** and click on the **Paper** tab. If you started from a supplied template, make note of the width and height of the page as you will need to use these values to set the cell size in the Excel template. See Fig. 2. If you're starting from scratch, set the width and height to the desired size of the label.

Now that you have the desired label size, its time to add the text to it. Keeping *Word* open, browse to the provided Excel template: **Number Sequence.xls**

This is a predefined template with the formula already in place to increment a numeric value by one.

1. Open the existing Excel template **Number Sequence.xls**

2. First, format the cells to match the size of label you have. Click on the upper left corner of the spreadsheet to highlight the entire document.

See Fig. 1.

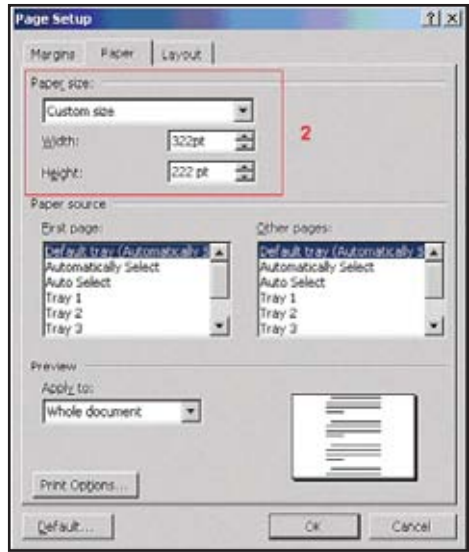

Fig. 2

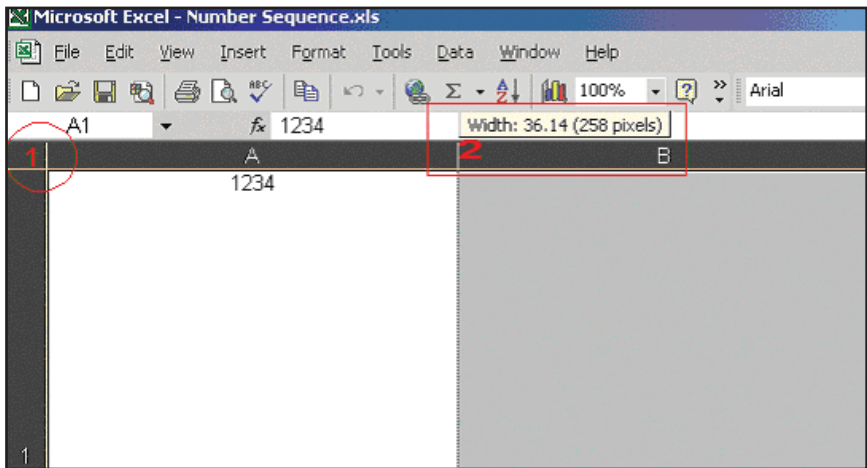

Fig. 3

3. Next, left-click and hold the column line between A and B. See Fig. 2. You can see a small box pops up giving you the pixel size of the width. You will want to set that value to the same width as your label. Do the same for the Row Height.

See Fig. 3.

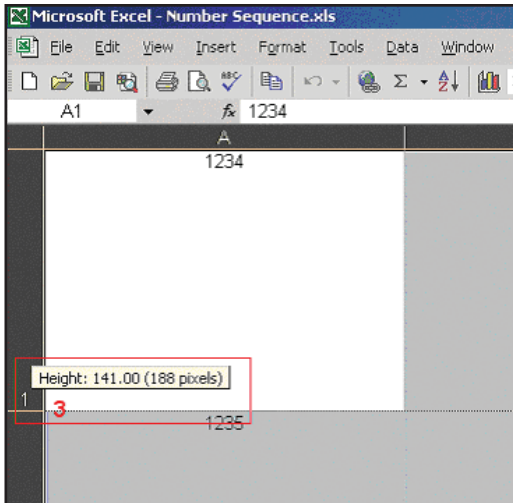

Fig. 4

- Now that you have the correct size matching your label, change the value in the first cell (*column A, row 1*) and enter any static text you want. Leave it blank for none. In the next cell (*column B, row 1*) enter the number you would like to increment. **See Fig. 4.** The next cell (*column C, row 1*) enter the value you would like to increment by Default is

1.

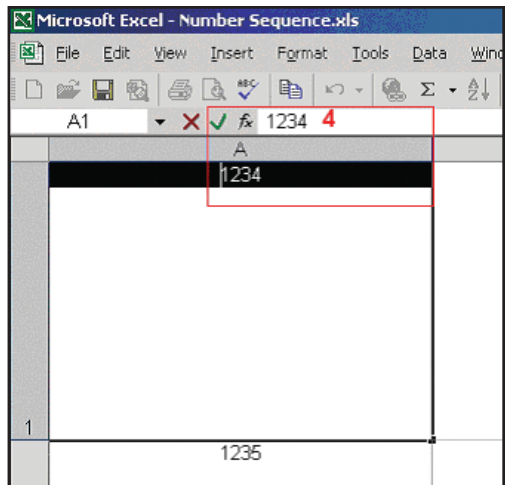
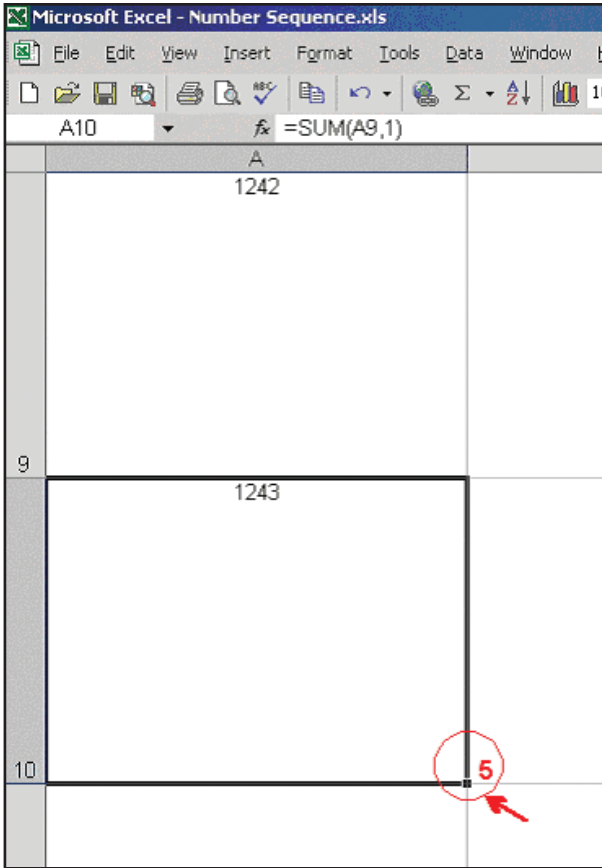

Fig. 5

After setting this, you should see the increment in each cell below cell 1. In this example, the cells have been adjusted in increments of 10. However, to increment further, simply left-click on cell 10 to highlight it, then left-click and hold on the small point in the lower right corner of the cell and drag down over how many cells you want to increment. **See Fig. 5.** Example: to increment the value 100 times, drag the cells down to the 100th row.

Once you're satisfied with the amount of increments and cell span, its time to copy this into your *Word* template. Go back to the *Word* document that you previously created. **!!Remember!!** The page layout of the *Word* template must match the cell size you specified in your Excel template.



Select the entire Column you just created by clicking on the top header of the cell. In this case, the "A." Go to **Edit >>> Copy**, to copy the entire column. Now switch over to your *Word* document, click anywhere inside your predefined page and go to **Edit >>> Paste**.

If the cells don't paste into the exact measurements of your label, adjust the margins so that they encompass the entire label.

You should be ready to print.

Import from Excel

How to transfer Excel spreadsheet information into a Word label

NOTE: These instructions are for users of Windows 2000. If you are using Windows XP, please follow the directions on page 35.

A. Merging *One Column* from a Spreadsheet to a Label:

1. Make sure the Excel file you are going to merge has been saved.
2. Open up the *Word* Document with the label template.

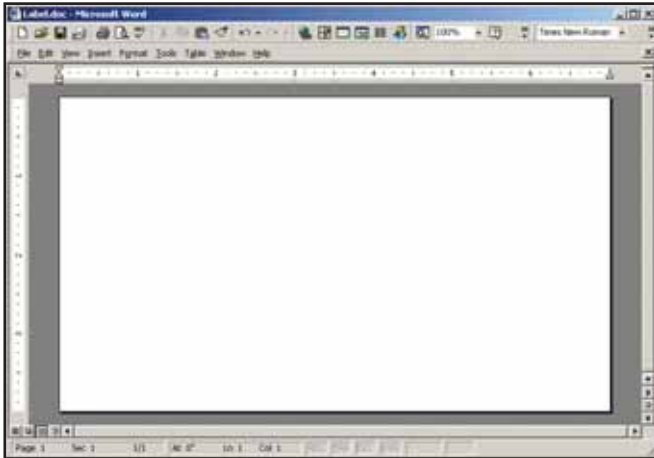

3. Alter the font in *Word* to the size of your choosing.
4. Open up the Excel file you intend to merge into the *Word* label.

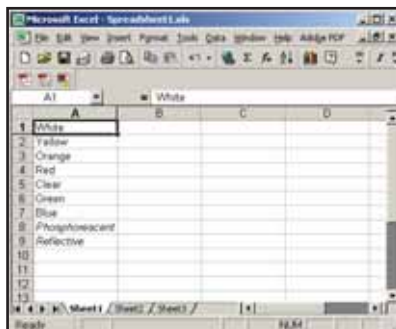

5. Click on column header A, right click the mouse, and select **Copy**.
6. Toggle (**Alt-Tab**) over to the *Word* document and find the **Edit** button on the Windows Tool Bar (*top left of screen*) and then click and select **Paste Special**.
7. Next, select **Unformatted Text** and click **OK**.

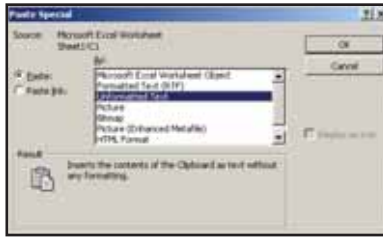

8. The Excel column should now be in the *Word* label. You are now ready to print your labels.



B. Merging *Multiple Columns* from a Spreadsheet to a Label:

1. Open the saved Excel document you plan to merge into Word.
2. Open your blank label template within *Word*.

3. On the toolbar on top of *Word*, click on **Insert**, then click **Text box**.

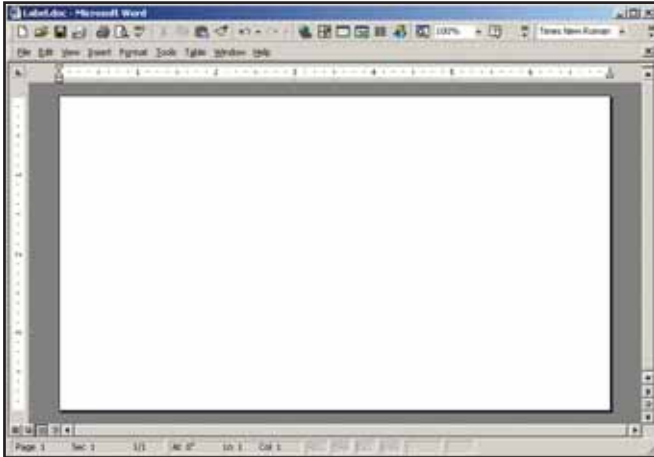

4. Use the cross hair cursor. Click in the field of the document, a text box will appear.

5. Resize the text box to your preference. See below

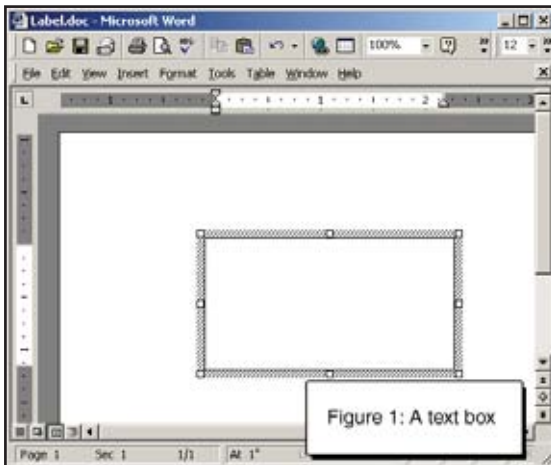

6. When the text cursor is blinking in the text box, click on the **Insert** menu and select **Field**.

7. The box on the left should remain with the blue highlighting of the word "All".

8. On the right column, move the cursor so the blue highlight is over **MergeField**.

9. In the long horizontal box below, "MERGEFIELD" will appear.

10. Put a space after “MERGEFIELD” then type in the column heading from your Excel document that you will want to merge into the label (*i.e.*, “Input.”)
11. It will then look like this: “MERGEFIELD Input.” See below



12. Click **OK** and the box will vanish.
13. At this point, you should have the word “Input” (*for example*) in your text box.
14. Create an additional text box(es) within the label and repeat steps 3-12 for each additional cell you plan to transfer from the Excel document into the *Microsoft Word* label.
15. Close the Excel document.
16. On the word toolbar, click on **Tools** then **Merge documents**.
17. At the bottom, click the **Files of Type** drop-down menu.
18. Click on the **All Files** item, then find the file name of the Excel document you plan to merge into Word.
19. Note – make sure you are looking in your **My Documents** folder.
20. Double-click on the correct Excel document.

21. On the next box you see, “ENTIRE WORKBOOK” will be blue highlighted.

Click **OK**.

22. You will then see a pop up box with a question mark. Click **OK**.

23. On your Word document, click on **Tools**, then **Mail merge**.

24. Click on **Create**, then **Form Letters**, then click **Active Window**.

See below



25. Click on **Get Data**, then click on **Open Data Source**.

26. At the bottom, you will see **Files of Type**.

27. Click on the drop down of **All Files** at the bottom.

28. Find and **double-click** on the file name of your Excel document.

29. Click **OK**.

30. Click **Merge**.

31. Click **Merge** and the document will merge from Excel to *Word*.

You are now finished

Help is also available under the Word Toolbar. Click on **Help** and type in “Merge from Excel to *Word*,” then click on **Search**. Then click the option **Use mail merge...**

CLEANING & GENERAL MAINTENANCE

Cleaning of the Cutter, Print Head and Platen Roller

IMPORTANT! Always turn the printer OFF before cleaning, performing maintenance, or loading supplies. Always wait at least 5 seconds before turning ON the power.

Basic cleaning of the print head, cutter and platen roller will prolong the life of the printer and will aid in producing crisp, clear labels and signs with every print. Please refer to page 7 of the User's Guide for better clarification of Printer Inside Parts. Please view the DuraLabel PRO 300 Cleaning Video at: www.duralabel.com/duralabel-pro-300/dlp300-support.php

Print Head



Fig. 1 Print Head is the entire metal bar that sits under the top printer cover

1. Open printer cover and remove any loaded supplies, then lifting up.
2. Use a pair of scissors or blade to separate any ribbon from the ribbon spools.
3. Open a cleaning swab and place the swab between your forefinger and thumb. Squeeze swab until it snaps. Alcohol will be distributed to the cotton side of the swab.
4. Run the swab back and forth several times across the Print Head to remove any built-up adhesive, ribbon residue, or dust particles.
5. Clean the front and underside of the Print Head.



Fig. 2 The entire area outlined in white should be cleaned

Cutter



Fig. 3 Cutter Mechanism (detachable face in front of printer)

1. Open the Duralabel PRO 300 top cover.
2. Rewind any supply that may be loaded away from the cutting mechanism.
3. Open a cleaning swab and place the swab between your forefinger and thumb. Squeeze swab until it snaps. Alcohol will be distributed to the cotton side of the swab.
4. Run the swab back and forth several times across the cutting mechanism to remove any buildup of labeling adhesive.



Fig. 4 Cutter (cutting blades are located at the printed label opening)

Cleaning The Cutter From The Inside

As an option you may also remove the cutter from the printer to efficiently clean both sides of the cutting blades.

1. Gently but firmly, lift the cutting mechanism out of the printer with both hands. Wires will still be connected, so avoid pulling cutting mechanism too hard or too far from the printer. Doing so may damage wire connections.
2. Open a cleaning swab and place the swab between your forefinger and thumb. Squeeze swab until it snaps. Alcohol will be distributed to the cotton side of the swab.
3. Run the swab back and forth several times across the cutter to remove any buildup of labeling adhesive. Wait a few seconds for any alcohol to dry.
4. Replace the cutting mechanism by inserting tabs on the sides of the cutter into slots on printer as shown in the photo.

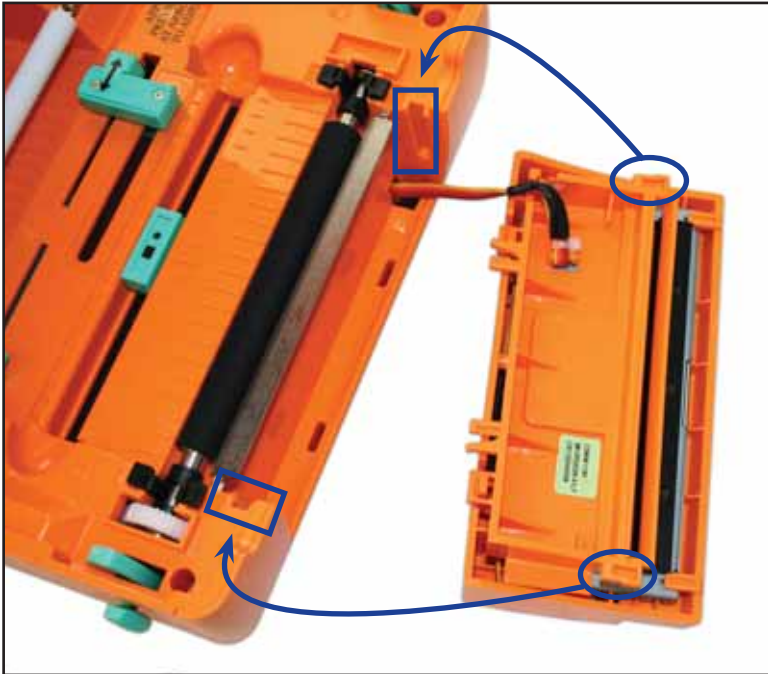

Fig. 5 Cutter Removed (fit the tab on the side of the cutter back in the provided slot)

NOTE

Be sure to place the wires back into the open slot they are connecting from. Do not allow the wires to get pinched when put back together.

Platen Roller

1. Remove the platen roller by squeezing the black tabs on either side of the platen roller and lifting up.

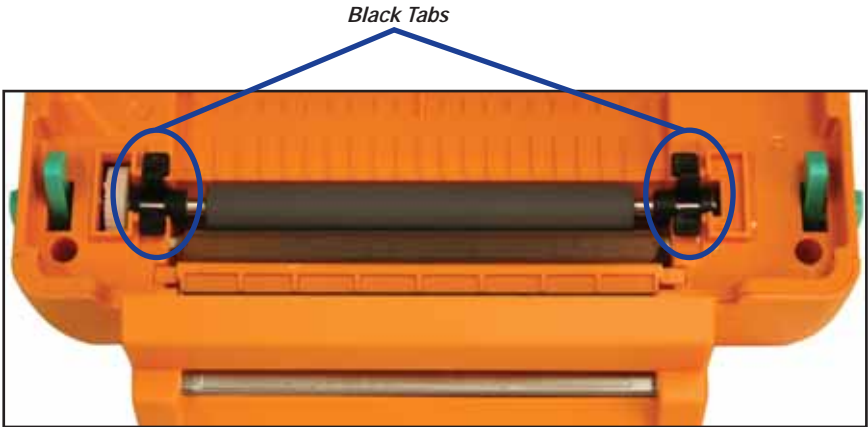

Fig. 6 Platen Roller

2. Open a cleaning swab and place the swab between your forefinger and thumb. Squeeze swab until it snaps. Alcohol will be distributed to the cotton side of the swab.
3. Run the swab back and forth several times across the Platen roller to remove any buildup.
4. Replace platen roller in printer
5. Give the Platen roller a couple minutes to dry, then reload your ribbon and supply.
6. Your Duralabel Pro 300 is now cleaned and ready for use.

The DuraLabel PRO 300 should be cleaned regularly to maintain optimal performance. The print head, cutter mechanism, and platen roller should be cleaned with alcohol swabs to remove buildup of adhesive, dust, and other substances. Always turn the printer OFF before cleaning, performing maintenance, or loading supplies.

NOTE

Please see the *DuraLabel PRO 300 Cleaning Video* located at www.duralabel.com/duralabel-pro-300/dlp300-support.php for proper step-by-step procedures.

TROUBLESHOOTING

SYMPTOM	NUMBER
LED is solid red	1
Print stops, LED blinks red.....	2
LED blinks amber & red	3
LED blinks red when printing die-cuts.....	4
LED blinks green	5
Printer feeds extra tape and blinks red.....	6
Cutter misses gap between die-cut labels.....	7
After label prints and cuts LED blinks amber & red	8
Printer fails to respond when print job is sent	9
Nonsense label prints.....	10
Print does not line up on shrink tube or 1/2" vinyl.....	11
Print mis-alignment.....	12
Poor print quality.....	13
Streaky print quality.....	14
Speckled print quality.....	15

TROUBLESHOOTING

The following are simple solutions to the most common printing challenges that occur with the DuraLabel® PRO. Please call Graphic Products for free technical support.

1. SYMPTOM: LED is solid (non-blinking) red.

a. Possible Cause: Cover is not latched properly.

Solution: Push down on both front corners of the printer to ensure both latches are secure.

2. SYMPTOM: Printing suddenly stops and LED blinks red.

a. Possible Cause: Either the label stock or the ribbon supply is out.

Solution: Replenish label stock or ribbon supply to continue printing.

b. Possible Cause: Media in use is too transparent.

Solution: Re-initialize the media and gap sensor:

1. Turn power OFF and wait 5 seconds.
2. Hold down the FEED button and turn the power ON.
3. When the LED steadily blinks red, release the button.

(See pages 12-15 of Printer's Manual)

c. Possible Cause: The ribbon supplies are loaded incorrectly.

Solution: Remove both ribbon spindles and place in the correct direction.

Flanges of spindles are on the right side of the printer. New ribbon supply goes on the rear hubs and used ribbon spindle (*with empty core*) goes on front hubs. Dull side of ribbon should face out and down towards label stock.

(See pages 12-15 of User's Guide or see supply loading video on DuraLabel PRO CD.)

3. SYMPTOM: LED blinks amber and red.

a. Possible Cause: Power was cycled too quickly.

Solution:

1. Turn power OFF.
2. Wait 5 seconds.
3. Turn power ON.

4. SYMPTOM: When using die-cuts, printing stops shortly after starting print job and LED blinks red.

Possible Cause: Gap sensor has not been initialized.

- Solution:**
1. Power OFF the printer and wait 5 seconds.
 2. Hold the FEED button while powering back ON the printer.
 3. Continue to hold FEED until the light flashes red, then release.

Note: Printer will dispense blank label stock as a result.

(See pages 12-13 of Printer's Manual)

5. SYMPTOM: After printing a label the LED blinks green.

Possible Cause: FEED button was pressed during printing.

Solution: Press the FEED button again to resume printing.

6. SYMPTOM: After printing a label, printer dispenses extra label stock and LED blinks red.

Possible Cause: The printer is set to print on "labels with gaps," even though stock being used is continuous feed.

- Solution:**
1. Open the Printers and Faxes folder.
 2. Right-click on the Graphic Products DuraLabel PRO.
 3. Select "Printing Preferences."
 4. Click the STOCK tab.
 5. Under "Media Settings" change "Type" to "Continuous."
 6. Click "Apply" then "OK."

(See pages 9-11 of User's Guide)

7. SYMPTOM: The print and cut are off the mark, when using die-cut stock.

Possible Cause: Print driver is set to print on continuous-feed tape even though the label stock has gaps between labels.

- Solution:**
1. Open the Printers and Faxes folder.
 2. Right-click on the Graphic Products DuraLabel PRO.
 3. Select "Printing Preferences."
 4. Click the STOCK tab.
 5. Under the "Media Settings" change "Type" to "Labels with Gaps."
 6. Click "Apply" then "OK." *(See page 10 of User's Guide)*

8. SYMPTOM: After first label prints, LED blinks amber and red.

Possible Cause: Printer could not recognize the label stock.

Solution: Only authorized supplies from Graphic Products will print correctly in the DuraLabel® PRO. If error occurred with Graphic Products supplies, contact Graphic Products for a replacement roll of label stock.

9. SYMPTOM: Printer does not respond, after sending print job.

a. Possible Cause: Printer is OFF.

Solution: Power ON the printer.

b. Possible Cause: Printer is on, but disconnected.

Solution:

1. Make sure the parallel cable connection is secured with the metal tabs in back of printer, or
2. USB cable is plugged in all the way on both printer and computer.
3. All screws on all serial cables are secured tightly.

c. Possible Cause: Printer is connected to a different port than the one specified in driver.

Solution: Re-configure the printer port through the driver:

1. Open the Printers and Faxes folder.
2. Right-click on the Graphic Products DuraLabel PRO.
3. Select "Properties."
4. Select "Ports."
5. Check the box of the port in use by printer.

Note: For parallel cable connection, select "LPT1."
For USB cable connection, select "USB001."

Note: If you are having difficulty printing with USB001, select a different port number such as, "USB002."

(See page 6 of User's Guide)

6. Click "Apply" then "OK."

Note: USB ports tend to 'hop' buses on some computers.

10. SYMPTOM: DuraLabel PRO prints nonsense information.

Possible Cause: Printer is in HEX dump mode. (See page 12 of Printer's Manual)

Solution:

1. Power OFF the printer.
2. Wait 5 seconds.
3. Without holding the FEED button, power ON the printer.

11. SYMPTOM: When using either small shrink tube or 1/2" vinyl, the print is not aligned correctly or is constantly shifting out of place.

Possible Cause: Tape guide is either not loaded properly or not loaded at all.

- Solution:**
1. With the smooth side of the tape guide faced up, position the uniquely shaped hole over that left spacer.
 2. Push it down so the guide is locked in with the spacer.
 3. Once in place, slide the spacers all the way together.
 4. Run the supply underneath guide and through divot on the underside.

12. SYMPTOM: The print is not aligned correctly or is constantly shifting.

Possible Cause: Adjustable label guides are not properly securing label stock.

- Solution:** Open top cover and move the guides towards each other to secure edges of label stock.

13. SYMPTOM: Print quality is poor.

a. Possible Cause: Cover not closed properly.

Solution: Close top cover completely and make sure the right side and left side levers are latched to top cover properly.

b. Possible Cause: Print darkness is set too high or too low.

Solution: Adjust the print darkness. *(See page 11 of User's Guide)*

1. Open the Printers and Faxes folder.
2. Right-click on the Graphic Products DuraLabel PRO and select "Printing Preferences."
3. Click the Option tab.
4. Clicking the arrow next to the Print Speed box.

c. Possible Cause: Print speed is set too high or too low.

Solution: Adjust the print speed. *(See page 11 of User's Guide)*

1. Open the Printers and Faxes folder.
2. Right-click on the Graphic Products DuraLabel PRO and select "Printing Preferences."
3. Click the Option tab.
4. Clicking and dragging the slider right or left.

14. SYMPTOM: Streaking occurs while printing.

a. Possible Cause: Ribbon was installed with too much slack or it was not centered, creating a crease in the ribbon.

Solution: Tighten the slack and eliminate all creases in the ribbon.

b. Possible Cause: Printer requires service.

Solution: Contact Graphic Products.

15. SYMPTOM: Speckling occurs while printing.

a. Possible Cause: Print head requires cleaning.

Solution: Use an alcohol cotton swab to clean the print head.

b. Possible Cause: Dust or other surface debris make it difficult for the resin to stick to vinyl or improperly stored.

Solution: Use only Graphic Products vinyl and store in dust-free conditions. Contact Graphic Products if problem persists.

SPECIFICATIONS

Printer

- Type: Thermal Transfer
- Print Speed: Selectable speeds of 2 and 3 inches per second
- Resolution: 203 DPI
- Max. Print Width: 4 in.
- Max. Print Length: 40 in.
- Ribbon Capacity: 984 ft.

Indicators & Buttons

- Indicators: PWR., ON-LINE, ERR.
- Buttons: POWER & FEED

Communication Interface

- Communications: USB v1.1, RS-232C (max baud rate 19,200 bps), & Centronics
- Memory: 1 MB Flash memory 2 MB DRAM

Power Requirements

- Input Voltage: Switching power, 100-240 VAC, 50-60 Hz
- Output Voltage: 24 VDC
- Circuit Protection: 3.75A maximum

Environment

- Operating Temperature: 41°F - 104°F (5°C - 40°C)
- Operation Humidity: 25% - 85% non-condensing
- Storage Temperature: -40°F - 140°F (40°C - 60°C)
- Storage Humidity: 10% - 90% non-condensing
- Ventilation: Free air movement

Label Stock

- Type: Continuous & Die-Cut
- Width: 0.5 in. - 4 in.
- Gap Height: 0.12 in. min.
- Black Mark Height: 0.08 in. min.
- Black Mark Width: 0.31 in. min.

Ribbon Supply

- Type: Wax, wax/resin, resin
- Capacity: 300 m. with 1 in. core

Printer Body

- Dimensions: 7.4 in. (H) x 8.4 in. (W) x 12.4 in. (L)

For more specifications, please see pages 19-20 of the DuraLabel PRO Printer Manual located on the DuraLabel PRO CD.



1-800-788-5572

P.O. Box 4030
Beaverton, OR 97076

www.DuraLabel.com

© 2007, 2008, 2009, Graphic Products, Inc. All Rights Reserved

v. 1.2 - 6/10/09